



Sürme Sistem
Sliding System



S35T



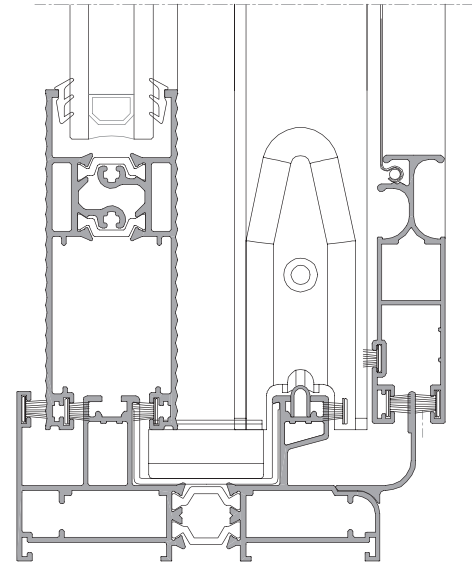

TEKNİK ÖZELLİKLER / TECHNICAL PROPERTIES

KASA DERİNLİĞİ / FRAME DEPTH	96 - 157,5 mm
KANAT DERİNLİĞİ / SASH DEPTH	35 mm
KENET DERİNLİĞİ / INTERLOCKING DEPTH	85 - 157 mm
PROFİL ET KALINLIĞI / PROFILE WALL THICKNESS	1,3 - 1,5 mm
ISI BARIYERİ / THERMAL BREAK	12 - 18 mm
MİN./MAKS. CAM KALINLIĞI / MIN./MAX. GLAZING THICKNESS	20 mm / 22 mm
MİN. KANAT ÖLÇÜLERİ / MIN. SASH DIMENSIONS	800 x 1900 mm
MAKS. KANAT ÖLÇÜLERİ / MAX. SASH DIMENSIONS	1600 x 2800 mm
MAKS. KANAT AĞIRLIĞI / MAX. SASH WEIGHT	160 kg
MİN. TERMAL ISI YALITIMI / MIN. THERMAL INSULATION	$U_f : 3,29 - 15,6 W / (m^2 \cdot K)$

UYGULAMA SEÇENEKLERİ / APPLICATION OPTIONS



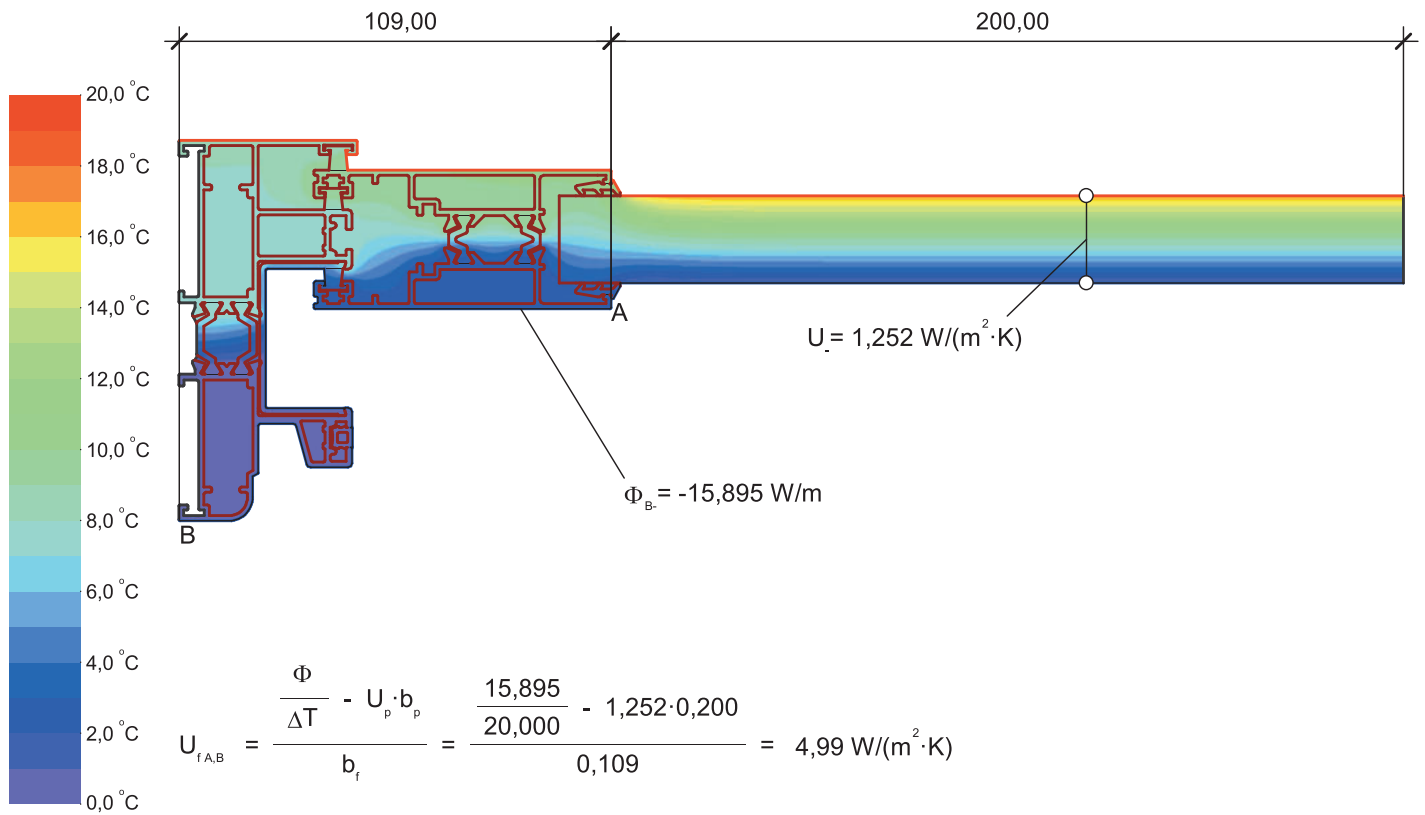

Material	λ [W/(m·K)]	ϵ	Boundary Condition	q [W/m ²]	θ [°C]	R [(m ² ·K)/W]	ϵ
Aluminium (Si Alloys)	160,000	0,900	Epsilon 0.9				0,900
EPDM (ethylene propylene diene monomer)	0,250	0,900	Exterior, frame	0,000		0,040	
PVC-U (polyvinylchloride), rigid	0,170	0,900	Interior, normal, horizontal	20,000		0,130	
Panel	0,035	0,900	Symmetry/Model section	0,000			
Polyamid 6.6 with 25% glass fibre	0,300	0,900					
Slightly ventilated air cavity	anisotropic						
Unventilated air cavity	anisotropic						

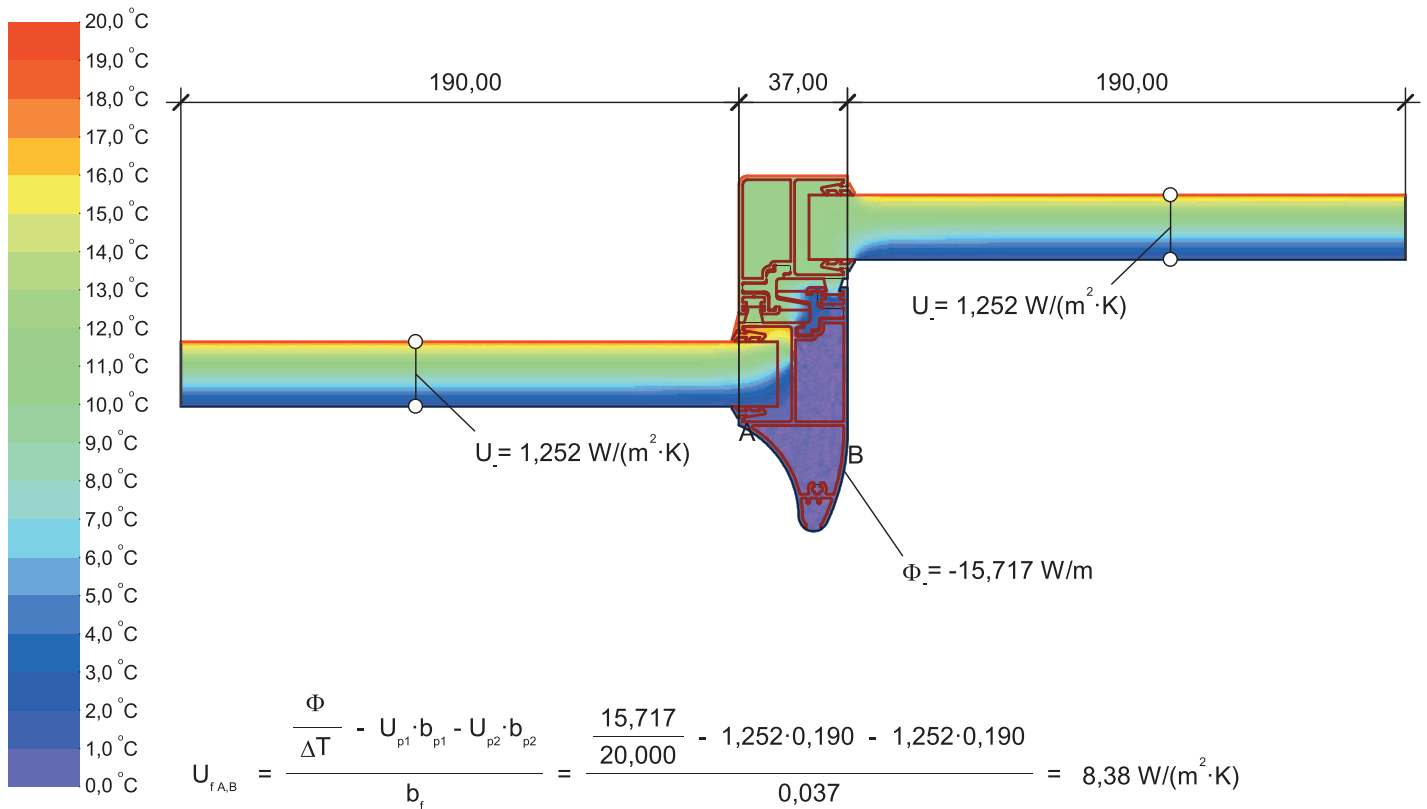

Material	λ [W/(m·K)]	ϵ	Boundary Condition	q [W/m ²]	θ [°C]	R [(m ² ·K)/W]	ϵ
Aluminium (Si Alloys)	160,000	0,900	Epsilon 0.9				0,900
EPDM (ethylene propylene diene monomer)	0,250	0,900	Exterior, frame	0,000		0,040	
Panel	0,035	0,900	Interior, normal, horizontal	20,000		0,130	
Polyamid 6.6 with 25% glass fibre	0,300	0,900	Symmetry/Model section	0,000			
Slightly ventilated air cavity	anisotropic						
Unventilated air cavity	anisotropic						

RÜZGAR YÜKÜNE GÖRE KULLANIM LİMİTLERİ GRAFİĞİ

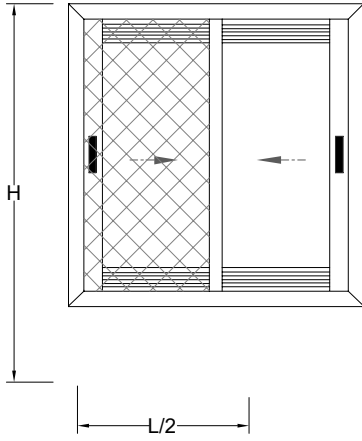

H(cm)

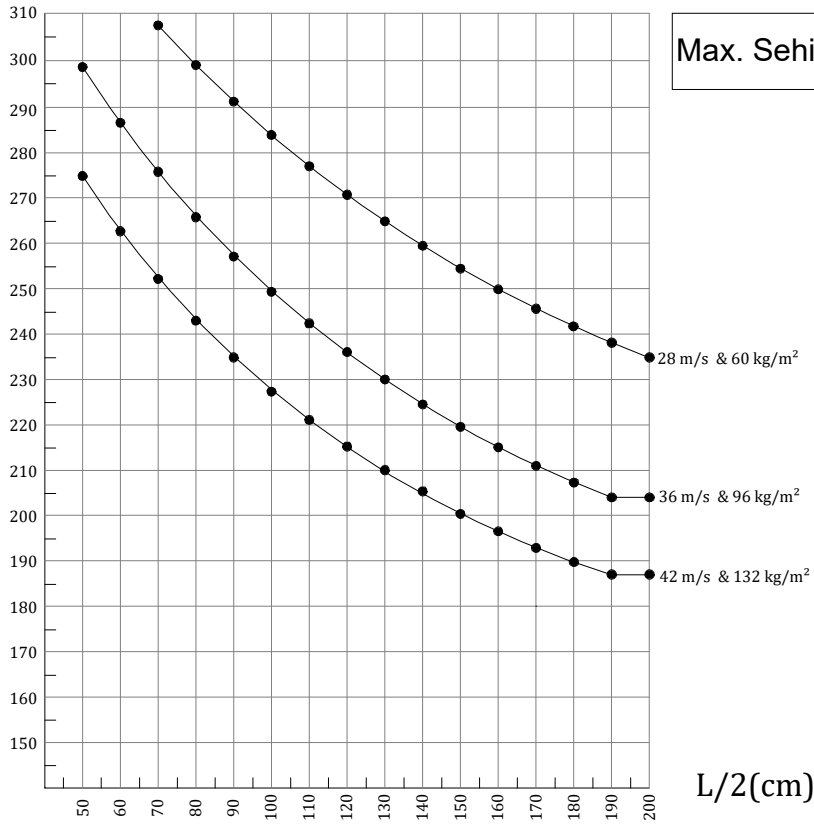

Max. Sehim : L / 300

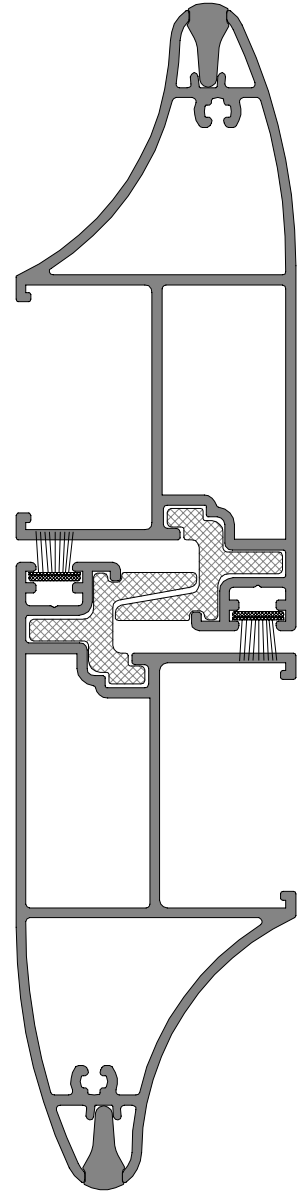

Ix : 43,6 cm⁴

RÜZGAR YÜKÜNE GÖRE KULLANIM LİMİTLERİ GRAFİĞİ

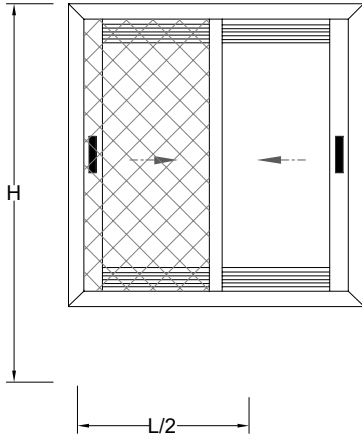

H(cm)

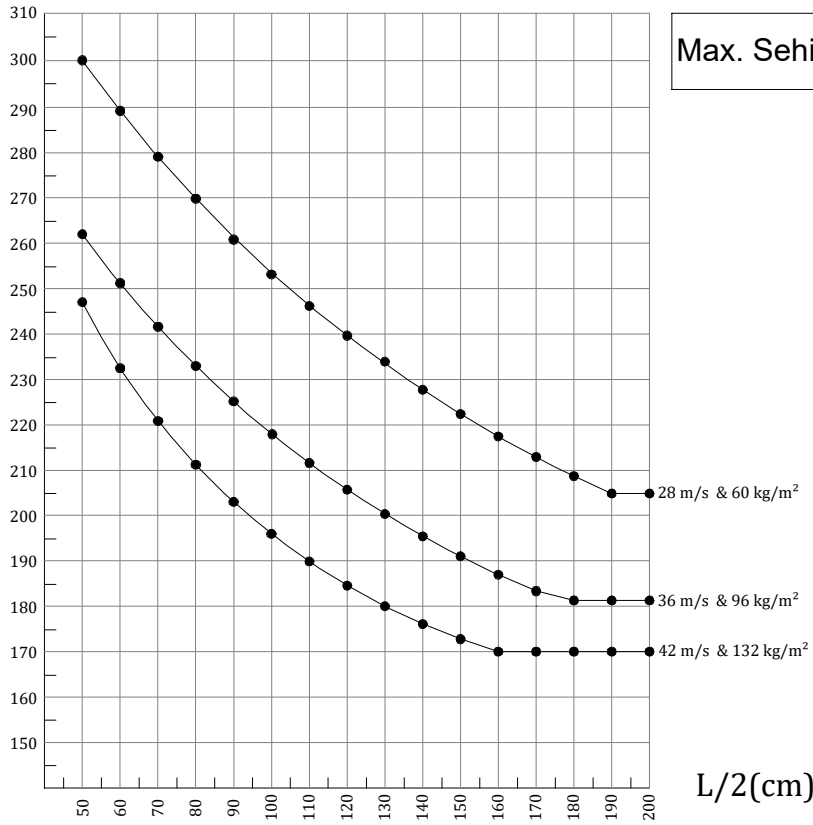

Max. Sehim : L / 300

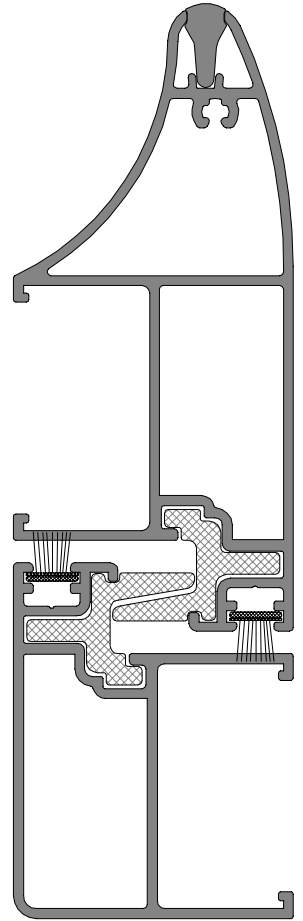

Ix : 27,8 cm⁴

RÜZGAR YÜKÜNE GÖRE KULLANIM LİMİTLERİ GRAFIĞI

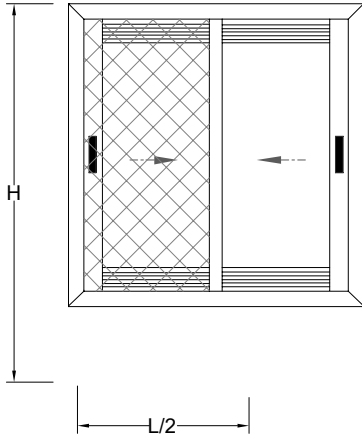



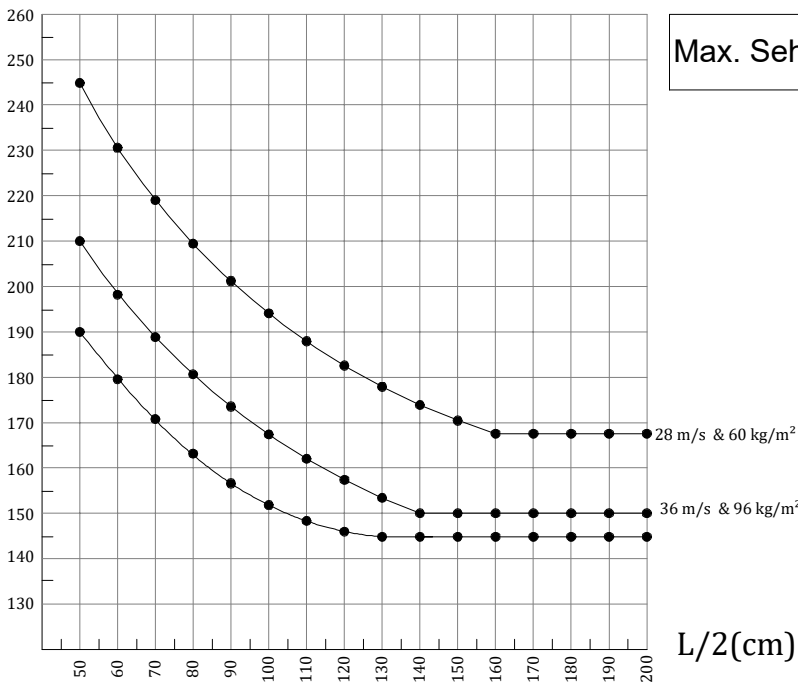



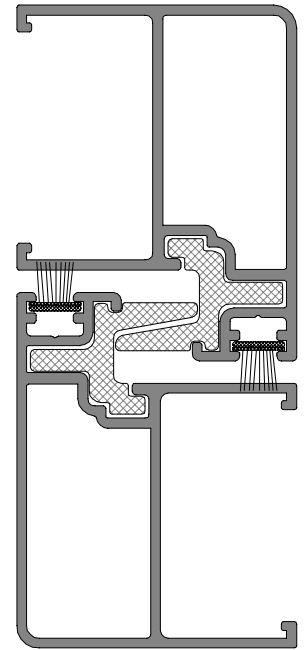

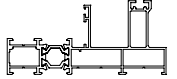
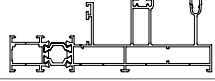
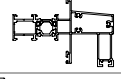
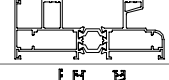

H(cm)

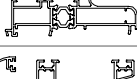
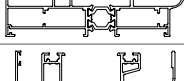
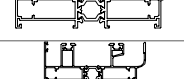
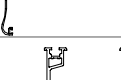

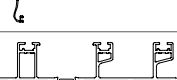
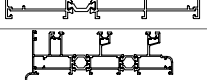
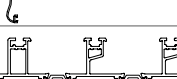
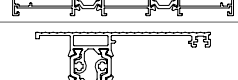
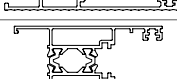



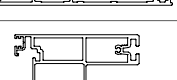
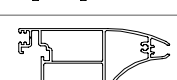
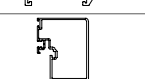





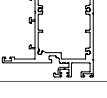
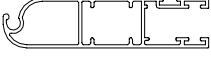

Max. Sehim : L / 300

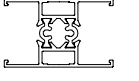

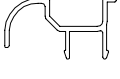



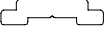





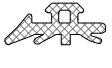





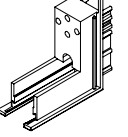
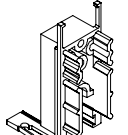
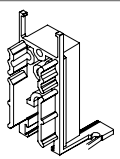
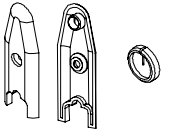

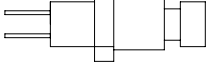
Ix : 12,4 cm⁴

PROFİL KESİTİ PROFILE SECTION	PROFİL KODU PROFILE CODE	PROFİL ADI PROFILE NAME	Jx cm ⁴	Jy cm ⁴	AĞIRLIK (kg/m) WEIGHT
	12651-12652	TEK RAYLI KASA PROFİLİ MONORAIL FRAME PROFILE	62,98 cm ⁴	10,68 cm ⁴	1,745 kg/m
	12651-12872	TEK RAYLI SİNEKLİKLİ KASA PROFİLİ MONORAIL SCREENING FRAME PROFILE	166,67 cm ⁴	13,75 cm ⁴	2,190 kg/m
	12651-12653	SABİTE GEÇİŞ PROFİLİ ADAPTER TO FIXED FRAME PROFILE	55,49 cm ⁴	15,95 cm ⁴	1,974 kg/m
	5846-3581	İKİ RAYLI KASA PROFİLİ DOUBLE RAIL FRAME PROFILE	55,21 cm ⁴	11,19 cm ⁴	1,799 kg/m
	5847-3581	İKİ RAYLI KASA PROFİLİ DOUBLE RAIL FRAME PROFILE	75,75 cm ⁴	25,87 cm ⁴	2,031 kg/m
	5853-5854	SABİT KASA PROFİLİ FIXED FRAME PROFILE	34,45 cm ⁴	4,48 cm ⁴	1,315 kg/m
	3592-3582	İKİ RAYLI SİNEKLİKLİ KASA PROFİLİ DOUBLE RAIL SCREENING FRAME PROFILE	99,46 cm ⁴	14,11 cm ⁴	2,140 kg/m
	5846-3582	İKİ RAYLI SİNEKLİKLİ KASA PROFİLİ DOUBLE RAIL SCREENING FRAME PROFILE	71,83 cm ⁴	12,21 cm ⁴	1,952 kg/m
	5847-3582	İKİ RAYLI SİNEKLİKLİ KASA PROFİLİ DOUBLE RAIL SCREENING FRAME PROFILE	96,00 cm ⁴	27,51 cm ⁴	2,185 kg/m
	5846-3584-3582	ÜÇ RAYLI SİNEKLİKLİ KASA PROFİLİ TRIPLE RAIL SCREENING FRAME PROFILE	228,22 cm ⁴	17,52 cm ⁴	2,866 kg/m
	5847-3584-3582	ÜÇ RAYLI SİNEKLİKLİ KASA PROFİLİ TRIPLE RAIL SCREENING FRAME PROFILE	279,38 cm ⁴	32,76 cm ⁴	3,098 kg/m
	5846-9782	ÜÇ RAYLI SİNEKLİKLİ KASA PROFİLİ TRIPLE RAIL SCREENING FRAME PROFILE	133,01 cm ⁴	14,46 cm ⁴	2,350 kg/m
	5847-3584-3581	ÜÇ RAYLI SİNEKLİKLİ KASA PROFİLİ TRIPLE RAIL SCREENING FRAME PROFILE	238,70 cm ⁴	31,25 cm ⁴	2,946 kg/m
	5846-3584-3581	ÜÇ RAYLI KASA PROFİLİ TRIPLE RAIL FRAME PROFILE	191,67 cm ⁴	16,39 cm ⁴	2,713 kg/m
	5859-5860	KANAT PROFİLİ SASH PROFILE	37,37 cm ⁴	10,58 cm ⁴	1,651 kg/m
	5841-5841	KANAT PROFİLİ SASH PROFILE	19,83 cm ⁴	8,22 cm ⁴	1,400 kg/m
	5855-5856	KANAT PROFİLİ SASH PROFILE	32,20 cm ⁴	8,50 cm ⁴	1,535 kg/m
	5841-5843	KANAT PROFİLİ SASH PROFILE	28,21 cm ⁴	22,59 cm ⁴	1,749 kg/m
	5857-5858	KANAT PROFİLİ SASH PROFILE	37,00 cm ⁴	10,59 cm ⁴	1,629 kg/m
	13811	KENET PROFİLİ INTERLOCKING PROFILE	33,69 cm ⁴	4,69 cm ⁴	1,455 kg/m
	5840	KENET PROFİLİ INTERLOCKING PROFILE	21,81 cm ⁴	4,12 cm ⁴	1,030 kg/m
	5862	KENET PROFİLİ INTERLOCKING PROFILE	21,56 cm ⁴	11,81 cm ⁴	1,100 kg/m

** Her profil için minimum sipariş 300 kg'dır.
** Minimum order quantity is 300 kg per profile.

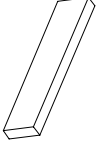
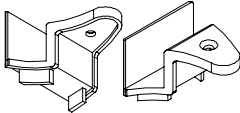
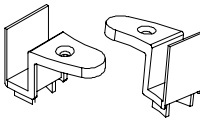
PROFİL KESİTİ PROFILE SECTION	PROFİL KODU PROFILE CODE	PROFİL ADI PROFILE NAME	Jx cm ⁴	Jy cm ⁴	AĞIRLIK (kg/m) WEIGHT
	12654	KENET PROFİLİ INTERLOCKING PROFILE	26,18 cm ⁴	9,08 cm ⁴	1,623 kg/m
	12655	KENET PROFİLİ INTERLOCKING PROFILE	40,03 cm ⁴	39,12 cm ⁴	2,435 kg/m
	5829	SİNEKLİK PROFİLİ SCREENING PROFILE	-	-	0,655 kg/m
	9780	SİNEKLİK PROFİLİ SCREENING PROFILE	-	-	0,860 kg/m
	12339	SİNEKLİK PROFİLİ SCREENING PROFILE	-	-	0,703 kg/m
	1243	SİNEKLİK PROFİLİ SCREENING PROFILE	-	-	0,434 kg/m
	5852-5852	ORTA KAYIT PROFİLİ MULLION PROFILE	-	-	1,066 kg/m
	12656	KAPAK PROFİLİ COVER PROFILE	-	-	0,405 kg/m
	9781	KAPAK PROFİLİ COVER PROFILE	-	-	0,211 kg/m
	3594	TAKVİYE PROFİLİ REINFORCE PROFILE	-	-	0,456 kg/m
	3595	TAKVİYE KAPAK PROFİLİ REINFORCE COVER PROFILE	-	-	0,101 kg/m
	13352-13352	ADAPTÖR PROFİLİ ADAPTER PROFILE	-	-	0,706 kg/m
	2707	SİNEKLİK RAY PROFİLİ SCREENING RAIL PROFILE	-	-	0,655 kg/m
	5845	TİJ PROFİLİ STEM BAR PROFILE	-	-	0,141 kg/m
	5844	KAPAK PROFİLİ COVER PROFILE	-	-	0,103 kg/m
	598	KÖŞE TAKOZ PROFİLİ CORNER WEDGE PROFILE	-	-	1,677 kg/m

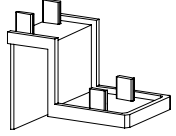
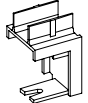
AKSESUAR ACCESSORY	STOK KODU REFERENCE CODE	AKSESUAR ADI DESCRIPTION	AKSESUAR KODU PRODUCT CODE	PAKET PACK
	AKS1297	RAY KAPAK FİTİLİ RAIL COVER GASKET	S35T-KRF.05	330 mt / paket 10 kg
	AKS1275	KASA FİTİLİ FRAME GASKET	S35T-KBF.36	350 mt / paket 10 kg/mt
	AKS1287	KANAT FİTİLİ SASH GASKET	S35T-KBF.56	330 mt / paket 10 kg/mt
	AKS1254	DIŞ CAM FİTİLİ OUTER GLAZING GASKET	S35T-DCF.30	215 mt / paket 10 kg
	AKS1338	İÇ CAM FİTİLİ INNER GLAZING GASKET	S35T-İCF.30	280 mt / paket 10 kg
	AKS1339	İÇ CAM FİTİLİ INNER GLAZING GASKET	S35T-İCF.40	220 mt / paket 10 kg
	AKS1341	İÇ CAM FİTİLİ INNER GLAZING GASKET	S35T-İCF.50	185 mt / paket 10 kg
	AKS4883	NOVOLINE ORTA BİRLEŞİM ADAPTÖR FİTİLİ MIDDLE JOINT ADAPTER GASKET	S35T-ADK.35	230 mt / paket 10 kg
	AKS1334	ORTA BİNE FİTİLİ MIDDLE GASKET (Tek raylı sistem için)	S35T-OBF.35	74 mt / paket 10 kg
	AKS1404	SIZDIRMAZLIK FİTİLİ SEALING GASKET (Tek raylı sistem için)	S35T-KAF.35	135 mt / paket 10 kg
	AKS913	KANAT KÖŞE BAĞLANTI SASH CORNER JOINT	S35T-KKB.400	100 ad / paket
	AKS914	KENET KÖŞE BAĞLANTI INTERLOCKING CORNER JOINT	S35T-KKB.401	100 ad / paket
	AKS915	KENET KÖŞE BAĞLANTI (TERS) INTERLOCKING CORNER JOINT (SYMMETRY)	S35T-KKB.402	100 ad / paket
	AKS919	KENET KAPAĞI INTERLOCKING COVER	S35T-KP.411	100 ad / paket
	AKS928	KANAT SABİTLEME TAKOZU SASH FIXING WEDGE	S35T-KST.460	100 ad / paket
	AKS5299	ELEKTRONİK SWITCH ELEKTRONIC SWITCH	S35T-ES.99	1 ad / paket
	AKS944	ÜST HAVA KESİCİ TOP AIR BLOCKER	S35T-ÜHK.610	1 ad / paket
	AKS920	ALT HAVA KESİCİ BOTTOM AIR BLOCKER	S35T-AHK.420	4 ad / paket

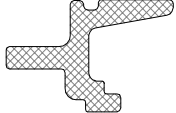
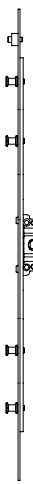
AKSESUAR ACCESSORY	STOK KODU REFERENCE CODE	AKSESUAR ADI DESCRIPTION	AKSESUAR KODU PRODUCT CODE	PAKET PACK
	AKS930	ÜST HAVA KESİCİ TOP AIR BLOCKER (Tek raylı sistem için)	S35T-ÜHK.471	1 ad / paket
	AKS931	ALT HAVA KESİCİ BOTTOM AIR BLOCKER (Tek raylı sistem için)	S35T-AHK.472	10 ad / paket
	AKS921	TAKVİYELİ KENET KAPAĞI REINFORCED INTERLOCKING COVER <small>5840 profil ile çalışır / For 5840</small>	S35T-TKK.430	100 ad / paket
	AKS922	TAKVİYELİ KENET KAPAĞI REINFORCED INTERLOCKING COVER <small>5841-5843 profil ile çalışır / For 5841-5843</small>	S35T-TKK.431	100 ad / paket
	AKS917	S35 STOPER S35 STOPPER	S35T-STP.409	250 ad / paket
	AKS5245	S35T TAKVİYELİ SLİM KENET PROFİL KAPAĞI S35T REINFORCED SLIM INTERLOCKING PROFILE COVER	S35T-STK.500	Adet
	AKS916	SPACER SPACER	S35T-SPC.408	100 ad / paket
	AKS466	KASA OLUK PLASTİĞİ FRAME GUTTER PART	S35T-KP.50	20 ad x 6m
	AKS932	KENET YALITIM PLASTİĞİ INTERLOCKING INSULATION PART	S35T-KYP.480	25 ad x 6 m
	AKS937	İSPANYOLET (40 cm) ESPAGNOLETTE (40 cm)	S35T-İSP.491	1 ad / paket
	AKS938	İSPANYOLET (80 cm) ESPAGNOLETTE (80 cm)	S35T-İSP.493	1 ad / paket
	AKS939	İSPANYOLET (100 cm) ESPAGNOLETTE (100 cm)	S35T-İSP.494	1 ad / paket
	AKS4142	İSPANYOLET (120 cm) ESPAGNOLETTE (120 cm)	S35T-İSP.492	1 ad / paket
	AKS941	İSPANYOLET (140 cm) ESPAGNOLETTE (140 cm)	S35T-İSP.496	1 ad / paket
	AKS942	İSPANYOLET (160 cm) ESPAGNOLETTE (160 cm)	S35T-İSP.497	1 ad / paket
	AKS943	İSPANYOLET (180 cm) ESPAGNOLETTE (180 cm)	S35T-İSP.498	1 ad / paket

AKSESUAR ACCESSORY	STOK KODU REFERENCE CODE	AKSESUAR ADI DESCRIPTION	AKSESUAR KODU PRODUCT CODE	PAKET PACK
	AKS923	İSPANYOLET KARŞILIK ESPAÑOLETE STRIKER	S35T-İK.440	25 ad / paket
	AKS4476	ROTO SECUSTİK PENCERE KOLU ROTO WINDOW HANDLE	S35T-RK.291	1 Pk / 20 Ad
	AKS739	İSPANYOLET PİMİ ESPAÑOLETE PIN	S35T-TP.100	1 pk / 100 ad
	AKS122	FORZA EKSENEL PENCERE KOL(BEYAZ) FORZA AXIAL WINDOW HANDLE(WHITE)	S35T-FPK.702	1 pk / 20 ad
	AKS123	FORZA EKSENEL PENCERE KOL(RENKLİ) FORZA AXIAL WINDOW HANDLE(COLORED)	S35T-FPK.703	1 pk / 20 ad
	AKS124	FORZA EKSENEL PENCERE KOL(NATUREL) FORZA WINDOW AXIAL HANDLE (NATURAL)	S35T-FPK.803	1 pk / 20 ad
	AKS4469	EKSENEL KOL ROTO(ELOKSALLI) ROTO AXIAL HANDLE(ANODIZED)	S35T-RK.601	1 pk / 10 ad
	AKS121	EKSENEL KOL ROTO(ELOKSALLI KİLİTLİ) ROTO AXIAL HANDLE(ANODIZED LOCKED)	S35T-RK.604	1 pk / 10 ad
	AKS126	FORZA EKSENEL KOL YENİ(NATUREL) FORZA NEW AXIAL HANDLE(NATURAL)	S35T-EK.810	1 pk / 50 ad
	AKS127	FORZA EKSENEL KOL YENİ(BEYAZ) FORZA NEW AXIAL HANDLE(WHITE)	S35T-EK.811	1 pk / 50 ad
	AKS128	FORZA EKSENEL KOL YENİ(RENKLİ) FORZA NEW AXIAL HANDLE(COLOURED)	S35T-EK.812	1 pk / 50 ad
	AKS30	SİSTEM PENCERE MENTEŞE (ELOKSALLI) SYSTEM WINDOW HINGE (ANODIZED)	S35T-PM.901	1 pk / 10 ad
	AKS31	SİSTEM PENCERE MENTEŞE (BEYAZ) SYSTEM WINDOW HINGE (WHITE)	S35T-PM.902	1 pk / 10 ad
	AKS32	SİSTEM PENCERE MENTEŞE (RENKLİ) SYSTEM WINDOW HINGE (COLORED)	S35T-PM.903	1 pk / 10 ad
	AKS743	AYARLI İSPANYOLET KARŞILIĞI(SETSKURLU) ESPAÑOLETE(PINNED)	S35T-TPK.201	1 pk / 100 ad
	AKS742	AYARLI İSPANYOLET KARŞILIĞI(VİDALI) ESPAÑOLETE(SCREWED)	S35T-TPK.200	1 pk / 100 ad
	AKS1916	CAM TAKOZU(5X28X80 mm) GLAZING WEDGE 5mm	S35T-CT.210	1 pk / 1000 ad
	AKS1915	CAM TAKOZU(5X20X80 mm) GLAZING WEDGE 5mm	S35T-CT.208	1 pk / 1000 ad
	AKS780	ALYAN KÖŞE BAĞLANTI ALLEN CORNER JOINT	S35T-MC.307	1 pk / 250 ad

AKSESUAR ACCESSORY	STOK KODU REFERENCE CODE	AKSESUAR ADI DESCRIPTION	AKSESUAR KODU PRODUCT CODE	PAKET PACK
	AKS370	FORZA YAYLI HAVUZ KOL (SİYAH) FORZA RECESSED HANDLE AUTOMATIC (BLACK)	S35T-FHK.750	1 pk / 40ad
	AKS371	FORZA YAYLI HAVUZ KOL (BEYAZ) FORZA RECESSED HANDLE AUTOMATIC (WHITE)	S35T-FHK.751	1 pk / 40ad
	AKS372	FORZA YAYLI HAVUZ KOL (NATUREL) FORZA RECESSED HANDLE AUTOMATIC (NATURAL)	S35T-FHK.752	1 pk / 40ad
	AKS373	FORZA YAYLI HAVUZ KOL (ANTRASİT) FORZA RECESSED HANDLE AUTOMATIC (ANTHRACITE)	S35T-FHK.753	1 pk / 40ad
	AKS374	FORZA MANUEL HAVUZ KOL (SİYAH) FORZA RECESSED HANDLE MANUEL (BLACK)	S35T-FHK.760	1 pk / 40ad
	AKS375	FORZA MANUEL HAVUZ KOL (BEYAZ) FORZA RECESSED HANDLE MANUEL (WHITE)	S35T-FHK.761	1 pk / 40ad
	AKS376	FORZA MANUEL HAVUZ KOL (NATUREL) FORZA RECESSED HANDLE MANUEL (NATURAL)	S35T-FHK.762	1 pk / 40ad
	AKS377	FORZA MANUEL HAVUZ KOL (ANTRASİT) FORZA RECESSED HANDLE MANUEL (ANTHRACITE)	S35T-FHK.763	1 pk / 40ad
	AKS378	FORZA ANAHTARLI HAVUZ KOL (SİYAH) FORZA RECESSED HANDLE LOCK WITH KEY (BLACK)	S35T-FHK.770	1 pk / 40ad
	AKS379	FORZA ANAHTARLI HAVUZ KOL (BEYAZ) FORZA RECESSED HANDLE LOCK WITH KEY (WHITE)	S35T-FHK.771	1 pk / 40ad
	AKS380	FORZA ANAHTARLI HAVUZ KOL (NATUREL) FORZA RECESSED HANDLE LOCK WITH KEY (NATURAL)	S35T-FHK.772	1 pk / 40ad
	AKS381	FORZA ANAHTARLI HAVUZ KOL (ANTRASİT) FORZA RECESSED HANDLE LOCK WITH KEY (ANTHRACITE)	S35T-FHK.773	1 pk / 40ad
	AKS386	FORZA PASİF HAVUZ KOL (SİYAH) FORZA RECESSED FINGER PULL HANDLE (BLACK)	S35T-FHK.790	1 pk / 40 ad
	AKS387	FORZA PASİF HAVUZ KOL (BEYAZ) FORZA RECESSED FINGER PULL HANDLE (WHITE)	S35T-FHK.791	1 pk / 40 ad
	AKS388	FORZA PASİF HAVUZ KOL (NATUREL) FORZA RECESSED FINGER PULL HANDLE (NATURAL)	S35T-FHK.792	1 pk / 40 ad
	AKS389	FORZA PASİF HAVUZ KOL (ANTRASİT) FORZA RECESSED FINGER PULL HANDLE (NATURAL)	S35T-FHK.753	1 pk / 40 ad
	AKS383	FORZA KİLİT DİLİ (ZAMAK) FORZA HOOK (ZAMAK) Forza yaylı ve manuel havuz kol ile kullanılmaktadır.	S35T-FKD.781	1 pk / 40 ad
	AKS382	FORZA KİLİT DİLİ (ZAMAK) FORZA HOOK (ZAMAK)	S35T-FKD.780	1 pk / 40 ad
	AKS384	FORZA KİLİT KARŞILIĞI (ZAMAK) FORZA STRIKER (ZAMAK)	S35T-FKK.782	1 pk / 40 ad

AKSESUAR ACCESSORY	STOK KODU REFERENCE CODE	AKSESUAR ADI DESCRIPTION	AKSESUAR KODU PRODUCT CODE		PAKET PACK
	AKS4882	NOVOLİNE SERİLER İÇİN ORTA BİRLEŞİM ADAPTÖR PLASTİĞİ MIDDLE JOINT ADAPTER PLASTIC FOR NOVOLINE SERIES	S35T-ADK.35 (PVC)		1 tk / 1 pk (1 Sağ , 1 Sol)
	AKS926	S35 ELİT ALÜMİNYUM AYARLI RULMAN S35 ELITE ALUMINIUM ADJUSTABLE ROLLER	S35T-AR.450	250 KG	1 pk / 100 ad
	AKS927	S35 FORZA ECO ALÜMİNYUM AYARLI RULMAN S35 FORZA ECO ALUMINIUM ADJUSTABLE ROLLER	S35T-FAR.455	130 KG	1 pk / 100 ad
	AKS1560	S35 PASLANMAZ ÇELİK RAY 8,3mm S35 STAINLESS STEEL RAIL 8,3 mm	S35T-PÇR.200		1 Boy x 6 m
	AKS924	KANÇA VE GÖVDE BODY SET	S35T-GT.441		1 pk / 25 ad
	AKS747	KÖŞE GÖNYE CORNER BRACKET (Tek raylı sistem için)	S35T-KG.178		1 pk / 500 ad
	AKS1608	AYARLI TEKLİ RULMAN ADJUSTABLE ROLLER (SINGLE)	S35T-AR.121		1 pk / 4 ad
	AKS1607	SAC KÖŞE BAĞLANTI SHEET CORNER CONNECTION	S35T-SC.150		1 pk / 400 ad
	AKS1596	SİNEKLİK TÜLÜ SCREENING NET	S35T-STF.80		24 m ² / paket
	AKS1597		S35T-STF.100		30 m ² / paket
	AKS1598		S35T-STF.120		36 m ² / paket
	AKS1599		S35T-STF.140		44 m ² / paket
	AKS1600		S35T-STF.160		48 m ² / paket
	AKS4331	SİNEKLİK FİTİLİ SCREENING GASKET	S35T-SF.114		1 pk / 100 m
	AKS1426		S35T-SF.115		
	AKS1427		S35T-SF.116		
	AKS1537	FIRÇA FİTİL WEATHER STRIP	S35T-FÇ.709		1 pk / 250 m
	AKS1539	FIRÇA FİTİL WEATHER STRIP	S35T-FÇ.711		1 pk / 250 m
	AKS1091	S35T KERTME BIÇAĞI S35T NOTCHING BLADE	S35T-KB.905		1 pk / 1 ad

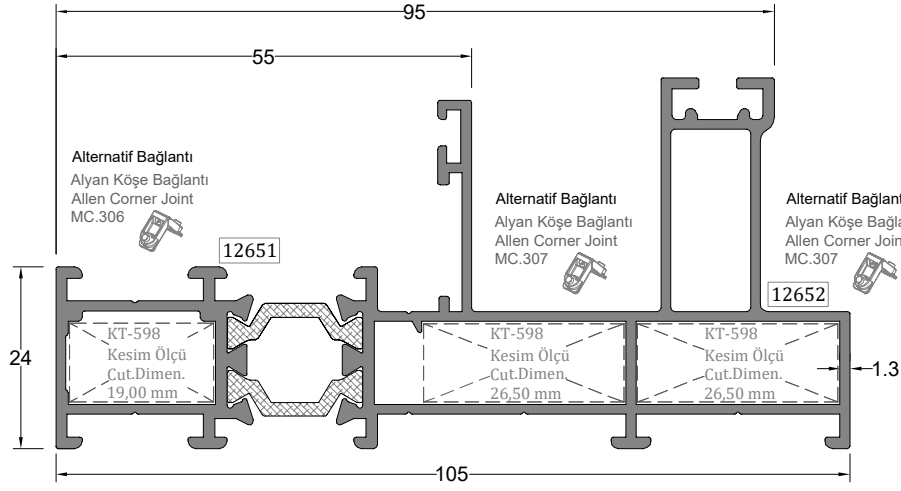

Tek Raylı Kasa Profili
MONORAIL FRAME PROFILE

Profil Kodu Profile Code	(kg/mt) Weight	Jx cm ⁴	Jy cm ⁴
12651-12652	1,745	62,98	10,68

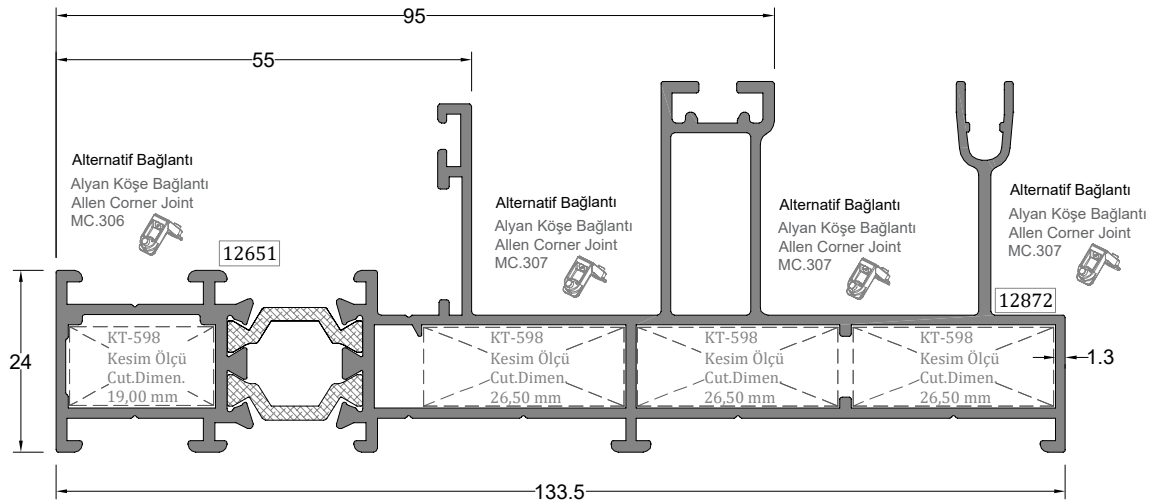

Tek Raylı Sineklikli Kasa Profili
MONORAIL SCREENING FRAME PROFILE

Profil Kodu Profile Code	(kg/mt) Weight	Jx cm ⁴	Jy cm ⁴
12651-12872	2,190	116,67	13,75

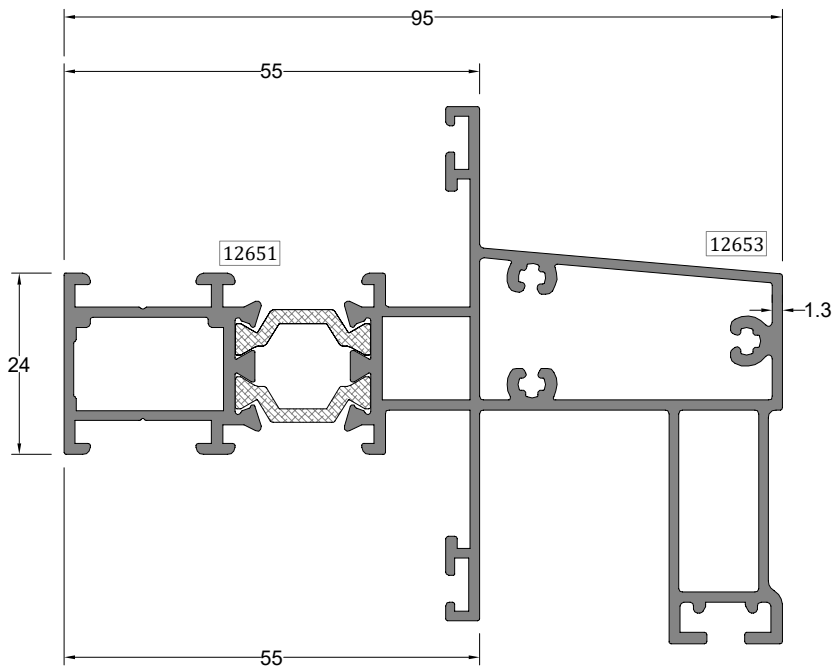

Sabite Geçiş Profili
ADAPTER TO FIXED FRAME

Profil Kodu Profile Code	(kg/mt) Weight	Jx cm ⁴	Jy cm ⁴
12651-12653	1,974	55,49	15,95

** Her profil için minimum sipariş 300 kg'dır.
** Minimum order quantity is 300 kg per profile.

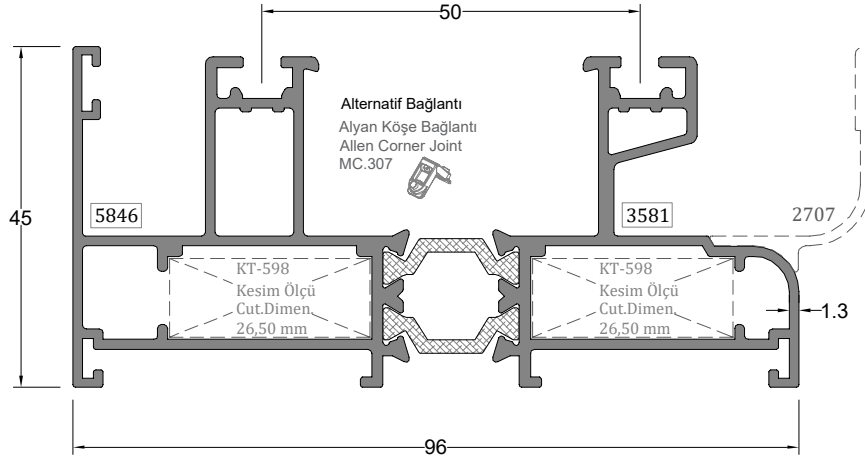

İki Raylı Kasa Profili
DOUBLE RAIL FRAME PROFILE

Profil Kodu Profile Code	(kg/mt) Weight	Jx cm ⁴	Jy cm ⁴
5846-3581	1,799	55,21	11,19

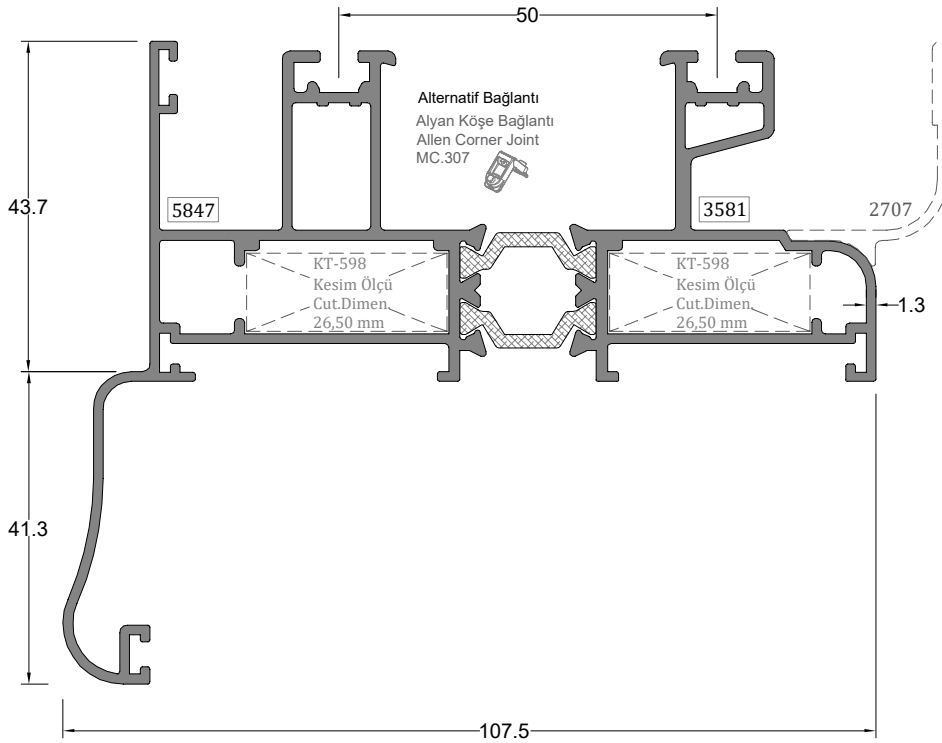

İki Raylı Kasa Profili
DOUBLE RAIL FRAME PROFILE

Profil Kodu Profile Code	(kg/mt) Weight	Jx cm ⁴	Jy cm ⁴
5847-3581	2,031	75,75	25,87

** Her profil için minimum sipariş 300 kg'dır.
** Minimum order quantity is 300 kg per profile.

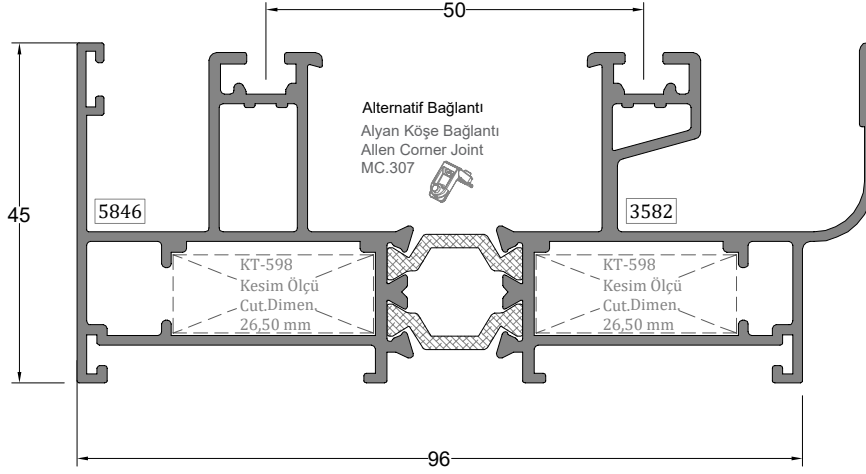

İki Raylı Sineklikli Kasa Profili DOUBLE RAIL SCREENING FRAME PROFILE	Profil Kodu Profile Code	(kg/mt) Weight	Jx cm ⁴	Jy cm ⁴
	5846-3582	1,952	71,83	12,21

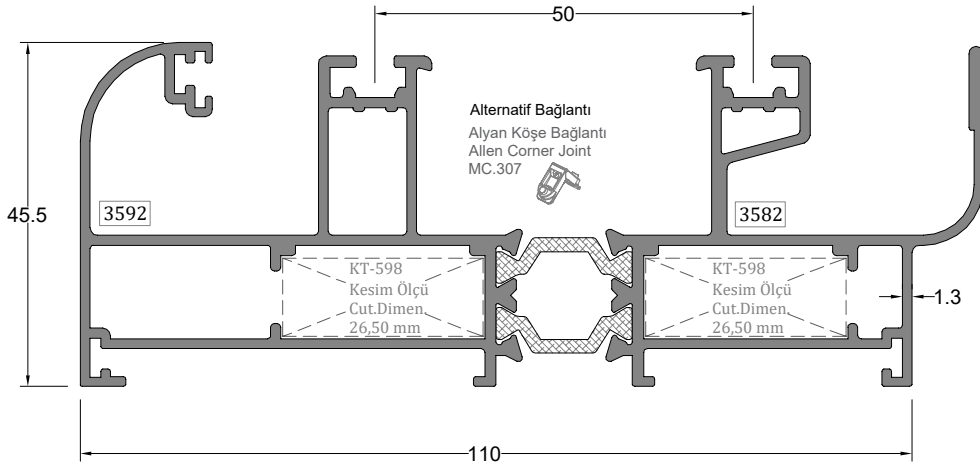

İki Raylı Sineklikli Kasa Profili DOUBLE RAIL SCREENING FRAME PROFILE	Profil Kodu Profile Code	(kg/mt) Weight	Jx cm ⁴	Jy cm ⁴
	3592-3582	2,140	99,46	14,11

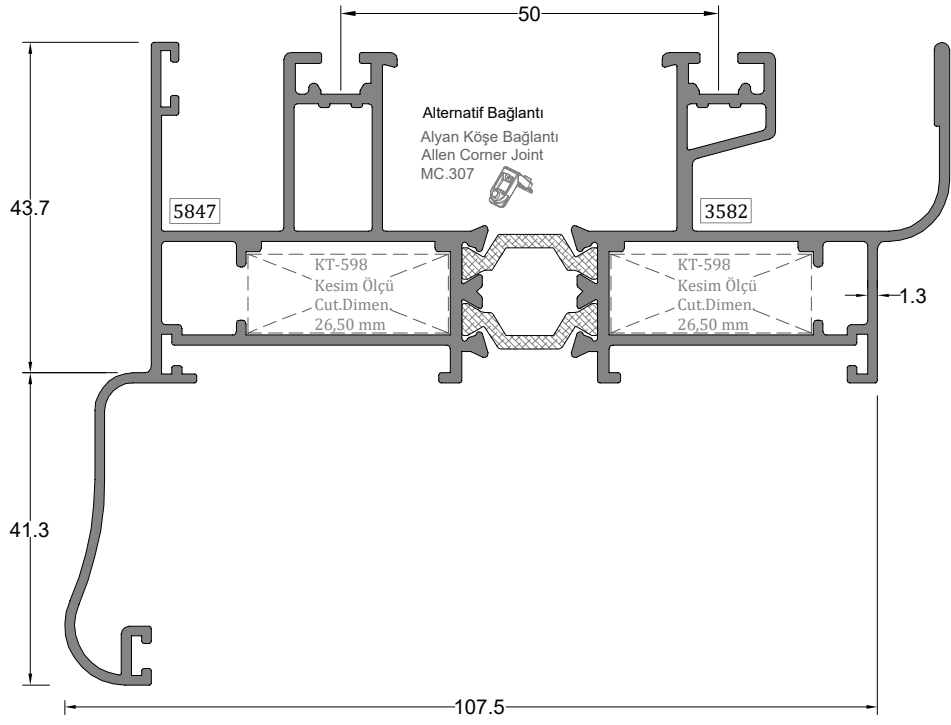

İki Raylı Sineklikli Kasa Profili
DOUBLE RAIL SCREENING FRAME PROFILE

Profil Kodu Profile Code	(kg/mt) Weight	Jx cm ⁴	Jy cm ⁴
5847-3582	2,185	96,00	27,51

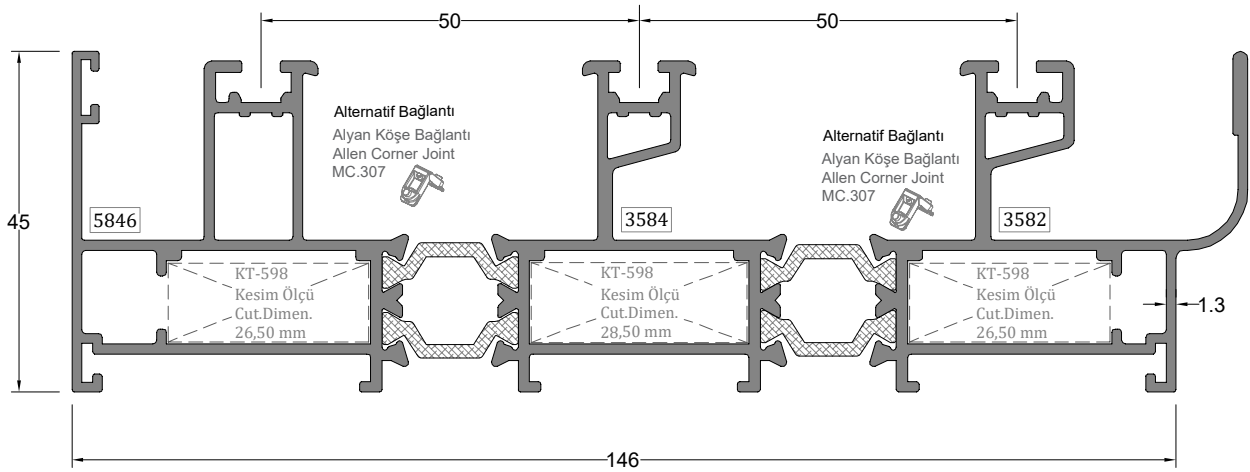

Üç Raylı Sineklikli Kasa Profili
TRIPLE RAIL SCREENING FRAME PROFILE

Profil Kodu Profile Code	(kg/mt) Weight	Jx cm ⁴	Jy cm ⁴
5846-3584-3582	2,866	228,22	17,52

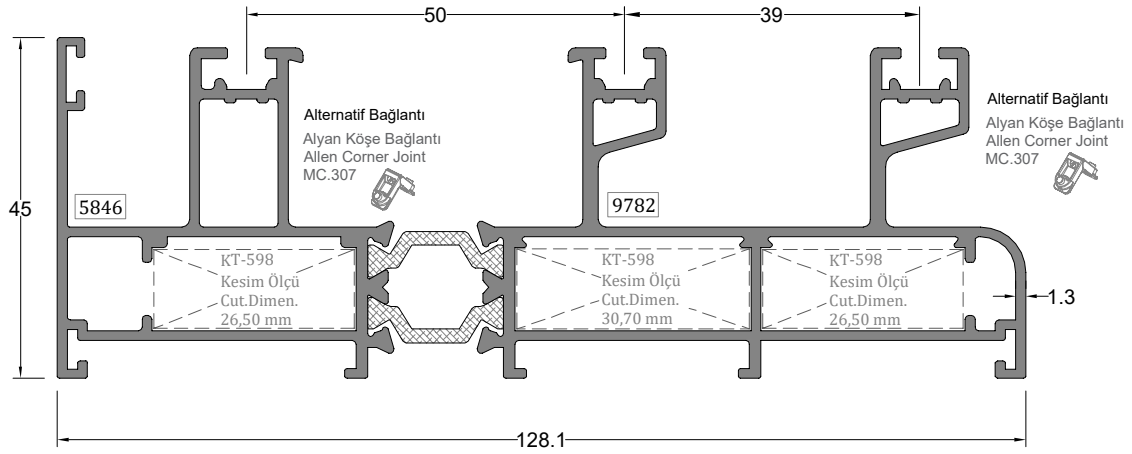

İki Raylı Sineklikli Kasa Profili
DOUBLE RAIL SCREENING FRAME PROFILE

Profil Kodu Profile Code	(kg/mt) Weight	Jx cm ⁴	Jy cm ⁴
5846-9782	2,350	133,01	14,46

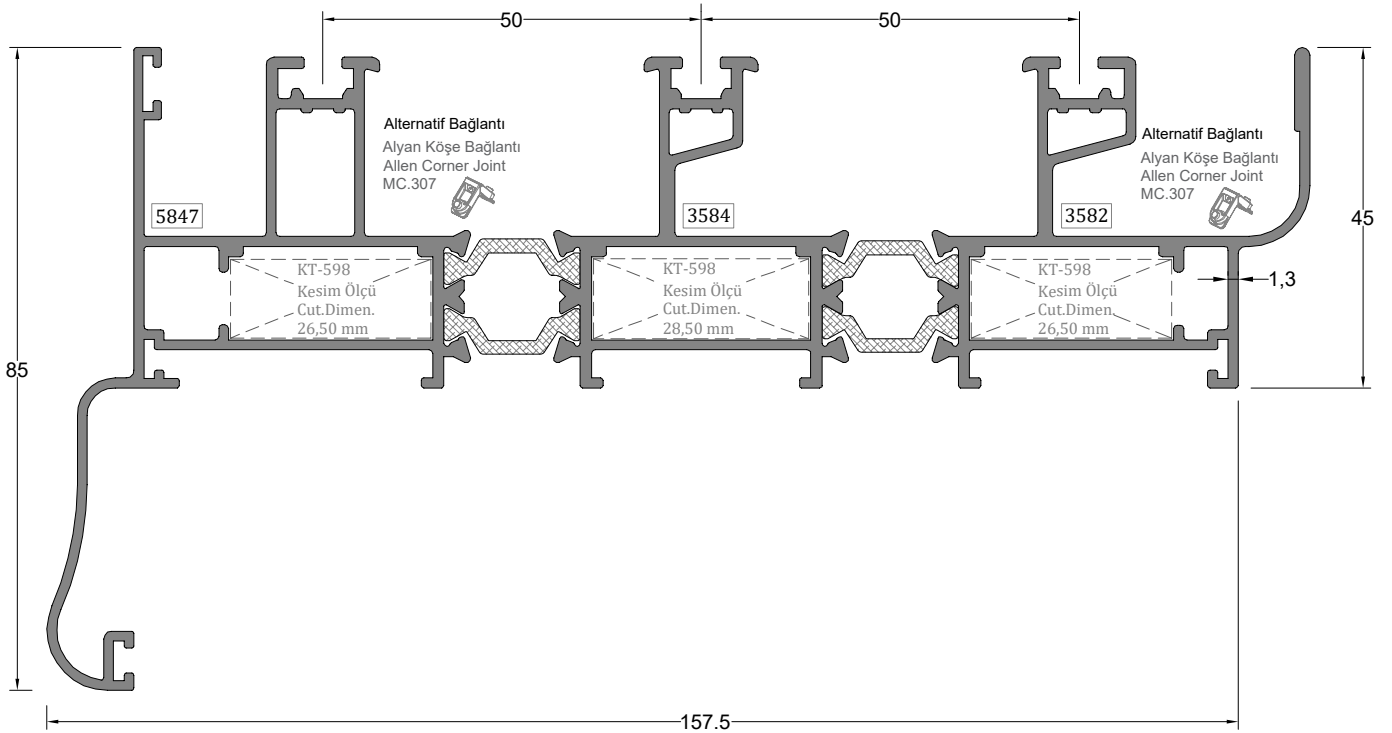

Üç Raylı Sineklikli Kasa Profili
TRIPLE RAIL SCREENING FRAME PROFILE

Profil Kodu Profile Code	(kg/mt) Weight	Jx cm ⁴	Jy cm ⁴
5847-3584-3582	3,098	279,38	32,76

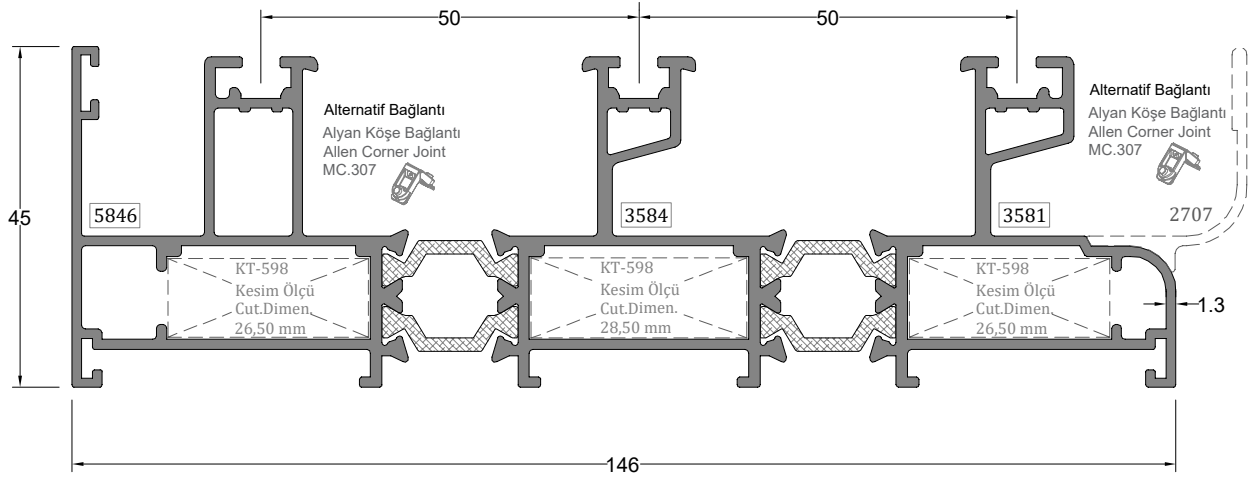

Üç Raylı Kasa Profili
TRIPLE RAIL FRAME PROFILE

Profil Kodu Profile Code	(kg/mt) Weight	Jx cm ⁴	Jy cm ⁴
5846-3584-3581	2,713	191,67	16,39

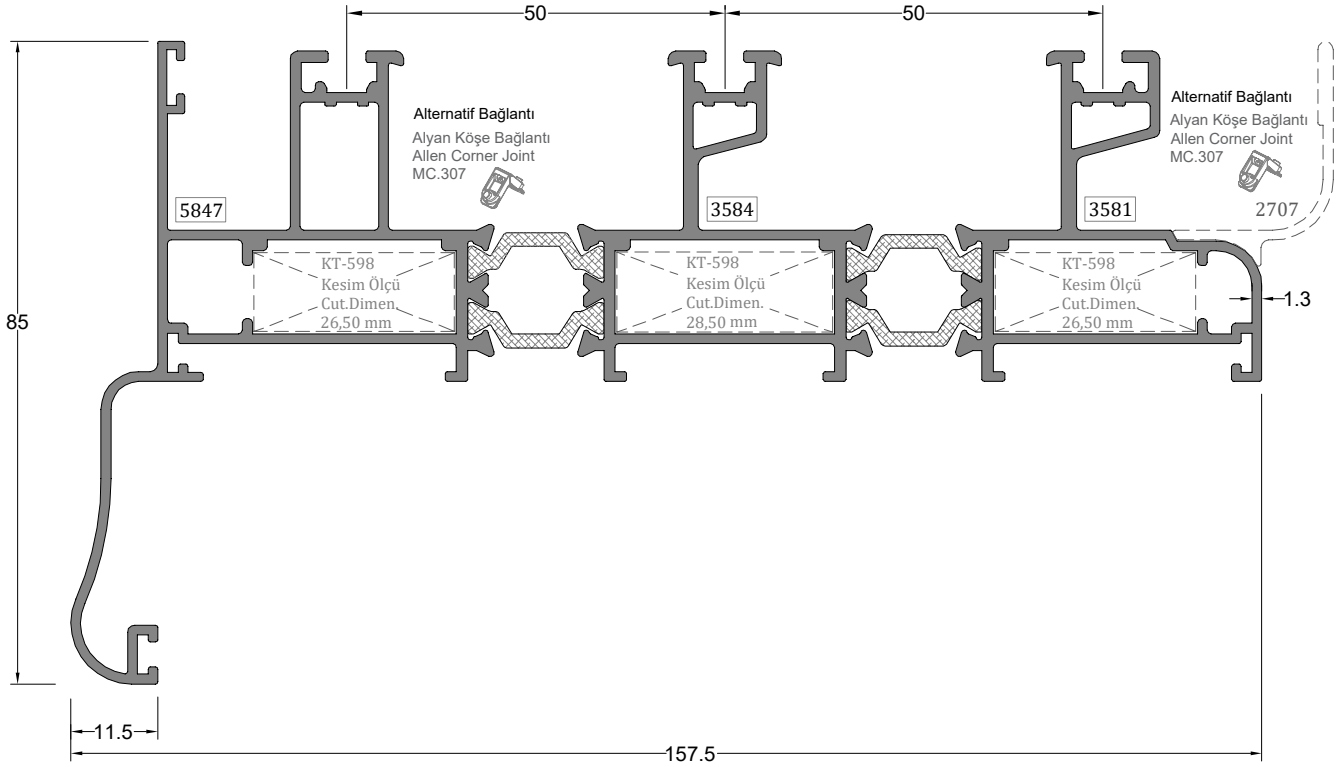

Üç Raylı Sineklikli Kasa Profili
TRIPLE RAIL SCREENING FRAME PROFILE

Profil Kodu Profile Code	(kg/mt) Weight	Jx cm ⁴	Jy cm ⁴
5847-3584-3581	2,946	238,70	31,25

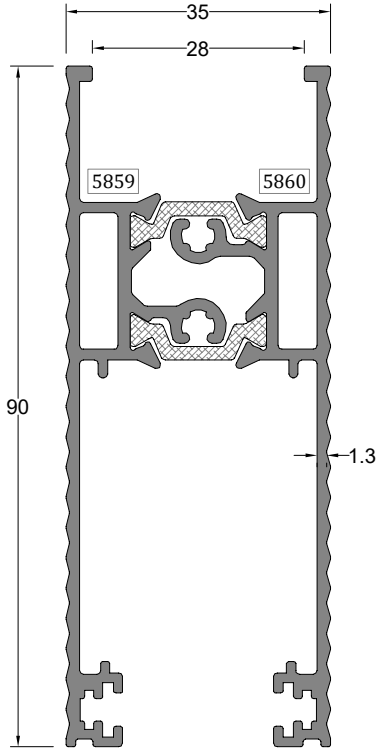

Kanat Profili	Profil Kodu	(kg/mt)	Jx cm ⁴	Jy cm ⁴
SASH PROFILE	Profile Code	Weight		
	5859-5860	1,651	37,37	10,58

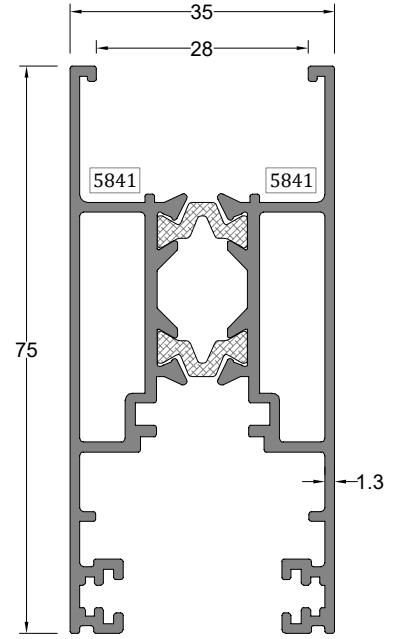

Kanat Profili	Profil Kodu	(kg/mt)	Jx cm ⁴	Jy cm ⁴
SASH PROFILE	Profile Code	Weight		
	5841-5841	1,400	19,83	8,22

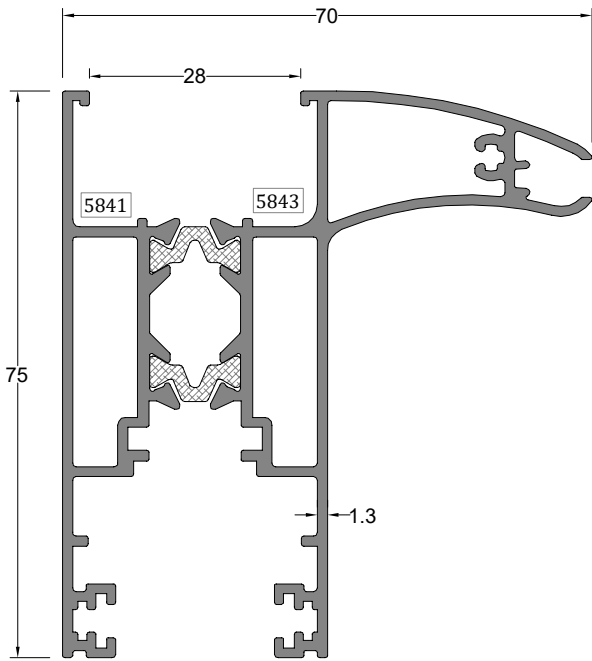

Kanat Profili	Profil Kodu	(kg/mt)	Jx cm ⁴	Jy cm ⁴
SASH PROFILE	Profile Code	Weight		
	5841-5843	1,749	28,21	22,59

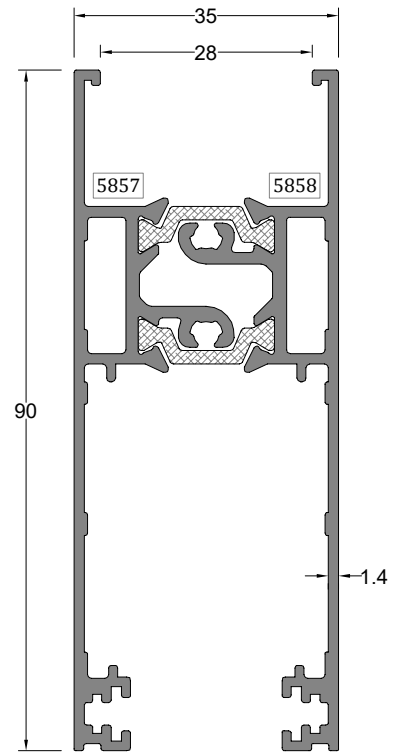

Kanat Profili	Profil Kodu	(kg/mt)	Jx cm ⁴	Jy cm ⁴
SASH PROFILE	Profile Code	Weight		
	5857-5858	1,629	37,00	10,59

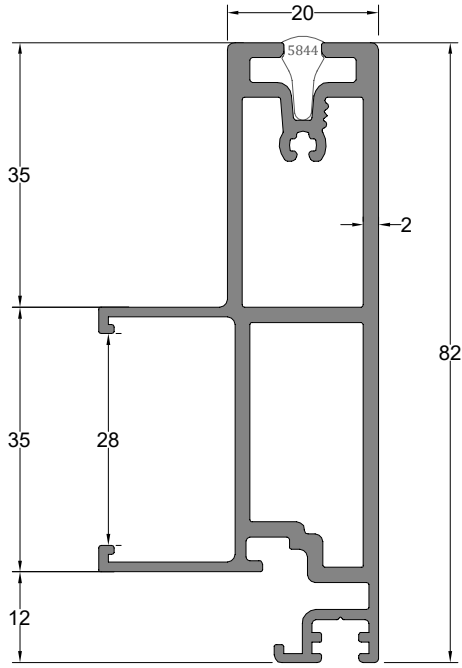

Kenet Profili	Profil Kodu	(kg/mt)	Jx cm ⁴	Jy cm ⁴
INTERLOCK PROFILE	Profile Code	Weight		
	13811	1,455	33,69	4,69

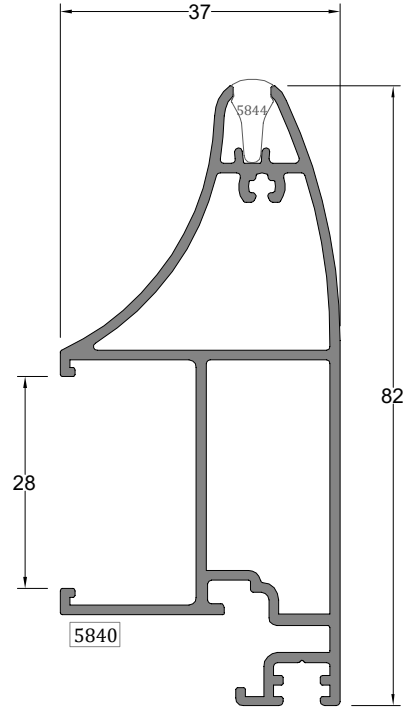

Kenet Profili	Profil Kodu	(kg/mt)	Jx cm ⁴	Jy cm ⁴
INTERLOCKING PROFILE	Profile Code	Weight		
	5840	1,030	21,81	4,12

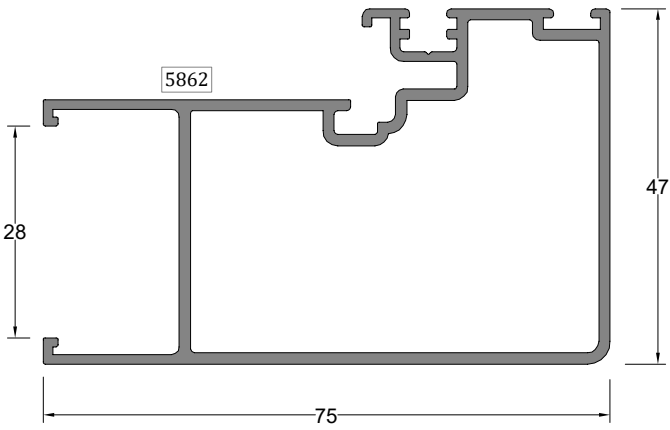

Kenet Profili	Profil Kodu	(kg/mt)	Jx cm ⁴	Jy cm ⁴
INTERLOCKING PROFILE	Profile Code	Weight		
	5862	1,100	21,56	11,81

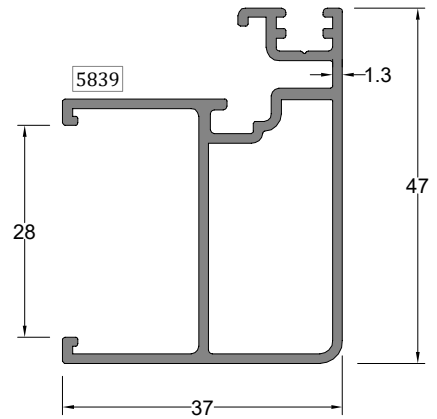

Kenet Profili	Profil Kodu	(kg/mt)	Jx cm ⁴	Jy cm ⁴
INTERLOCKING PROFILE	Profile Code	Weight		
	5839	0,662	6,02	2,90

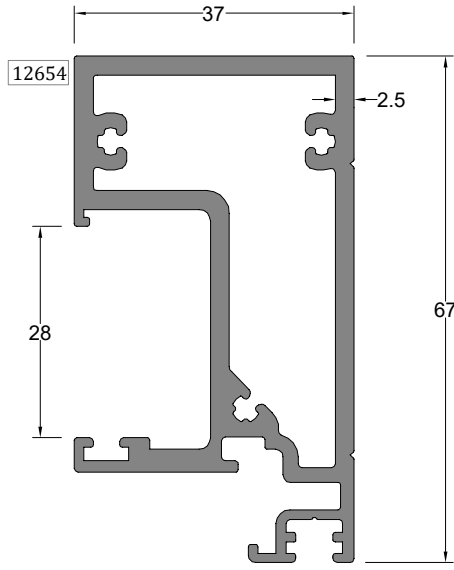

Kenet Profili	Profil Kodu	(kg/mt)	Jx cm ⁴	Jy cm ⁴
INTERLOCKING PROFILE	12654	1,623	26,18	9,08

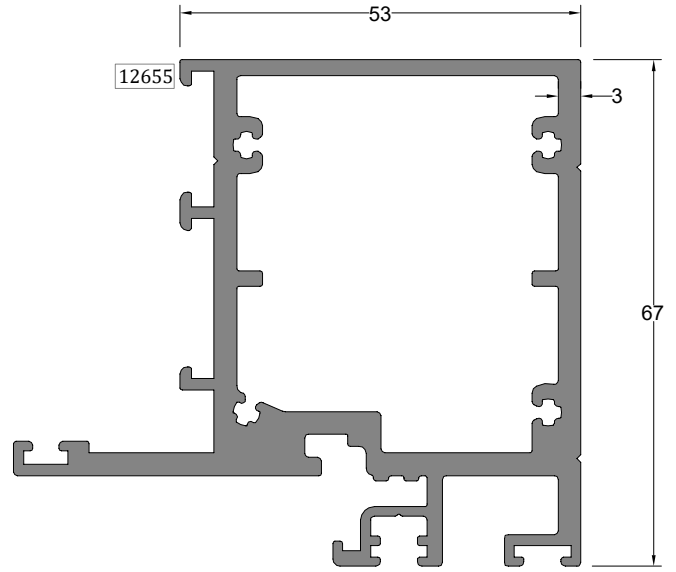

Kenet Profili	Profil Kodu	(kg/mt)	Jx cm ⁴	Jy cm ⁴
INTERLOCKING PROFILE	12655	2,435	40,03	39,12

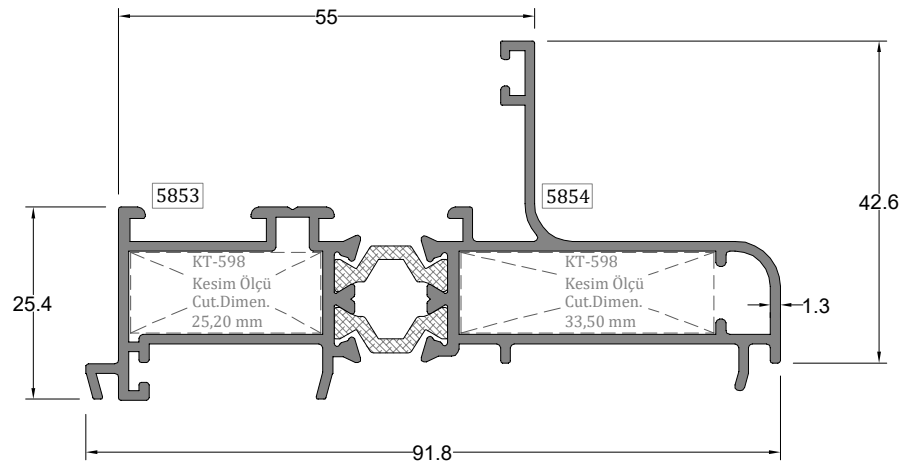

Sabit Kasa Profili	Profil Kodu	(kg/mt)	Jx cm ⁴	Jy cm ⁴
FIXED FRAME PROFILE	5853-5854	1,315	34,45	4,48

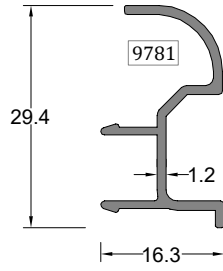
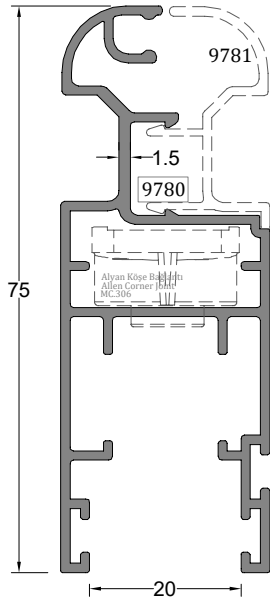

Sineklik Kapak Profili SCREENING COVER PROFILE	Profil Kodu Profile Code	(kg/mt) Weight
	9781	0,211

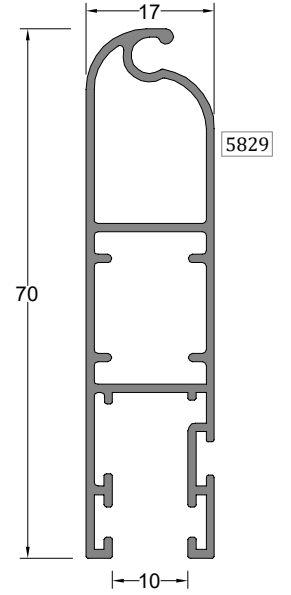

Sineklik Profili SCREENING PROFILE	Profil Kodu Profile Code	(kg/mt) Weight	Jx cm ⁴	Jy cm ⁴
	9780	0,860	13,87	3,30

Sineklik Profili SCREENING PROFILE	Profil Kodu Profile Code	(kg/mt) Weight	Jx cm ⁴	Jy cm ⁴
	5829	0,655	10,38	1,10

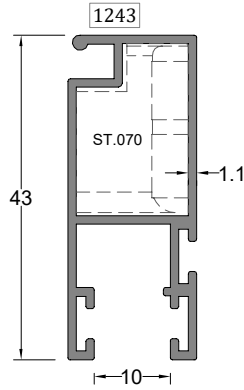

Sineklik Profili SCREENING PROFILE	Profil Kodu Profile Code	(kg/mt) Weight
	1243	0,434

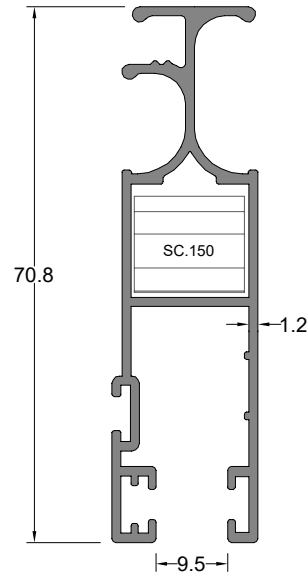

Sineklik Profili SCREENING PROFILE	Profil Kodu Profile Code	(kg/mt) Weight
	12339	0,703

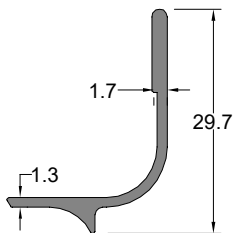

Sineklik Ray Profili SCREENING RAIL PROFILE	Profil Kodu Profile Code	(kg/mt) Weight
	2707	0,655

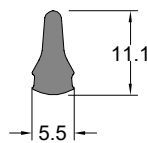

Kapak Profili COVER PROFILE	Profil Kodu Profile Code	(kg/mt) Weight
	5844	0,103

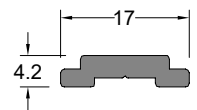

Tij Profili STEM BAR PROFILE	Profil Kodu Profile Code	(kg/mt) Weight
	5845	0,141

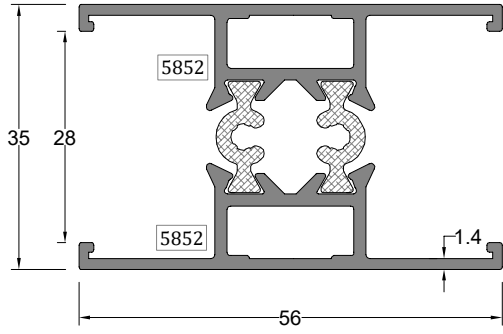

Orta Kayıt Profili MULLION PROFILE	Profil Kodu Profile Code	(kg/mt) Weight	Jx cm ⁴	Jy cm ⁴
	5852-5852	1,066	6,49	6,40

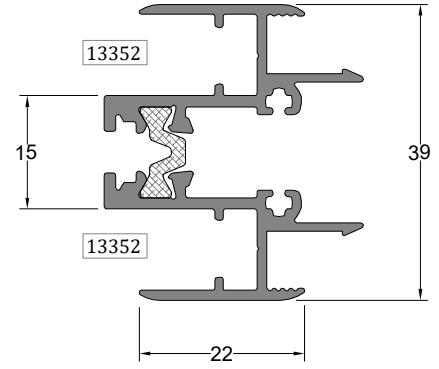

Adaptör Profili ADAPTER PROFILE	Profil Kodu Profile Code	(kg/mt) Weight
	13352-13352	0,706

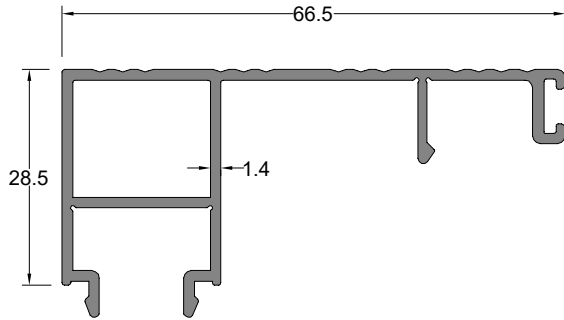

Çita Profili BEAD PROFILE	Profil Kodu Profile Code	(kg/mt) Weight
	12649	0,559

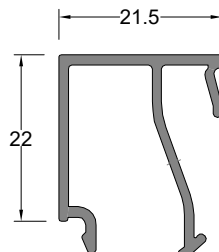
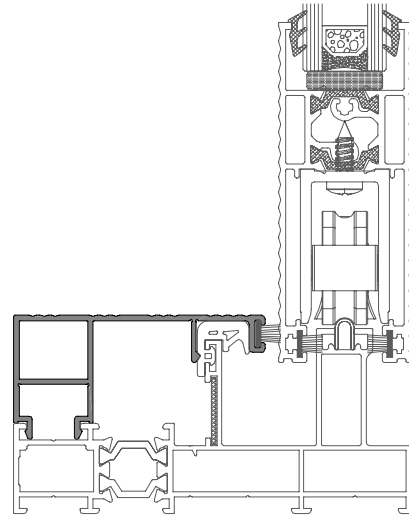

Cam Çitası GLAZING BEAD	Profil Kodu Profile Code	(kg/mt) Weight
	1745	0,292

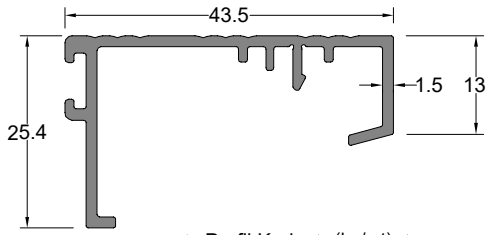

Kapak Profili COVER PROFILE	Profil Kodu Profile Code	(kg/mt) Weight
	12656	0,405

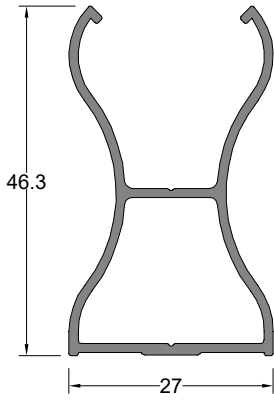
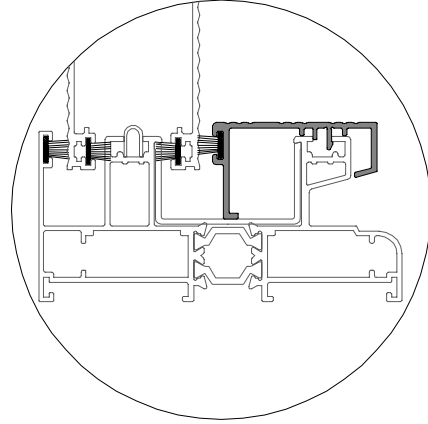

Takviye Profili REINFORCE PROFILE	Profil Kodu Profile Code	(kg/mt) Weight
	3594	0,456

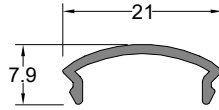

Takviye Kapak Profili REINFORCE COVER PROFILE	Profil Kodu Profile Code	(kg/mt) Weight
	3595	0,101

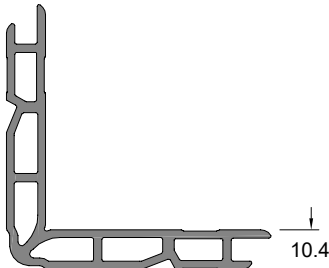
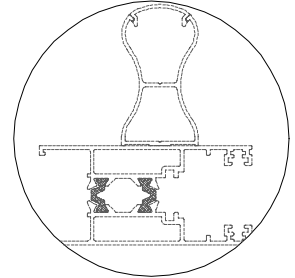

Köşe Takoz Profili CORNER WEDGE PROFILE	Profil Kodu Profile Code	(kg/mt) Weight
	598	1,677

Köşe Takozu Profil Kodu Corner Wedge Profile Code	Kullanıldığı Profil Used Profile	Kesim Boyu (mm) Cutting Length (mm)
598	3584	28,50 mm
	5853	25,20 mm
	5854	33,50 mm

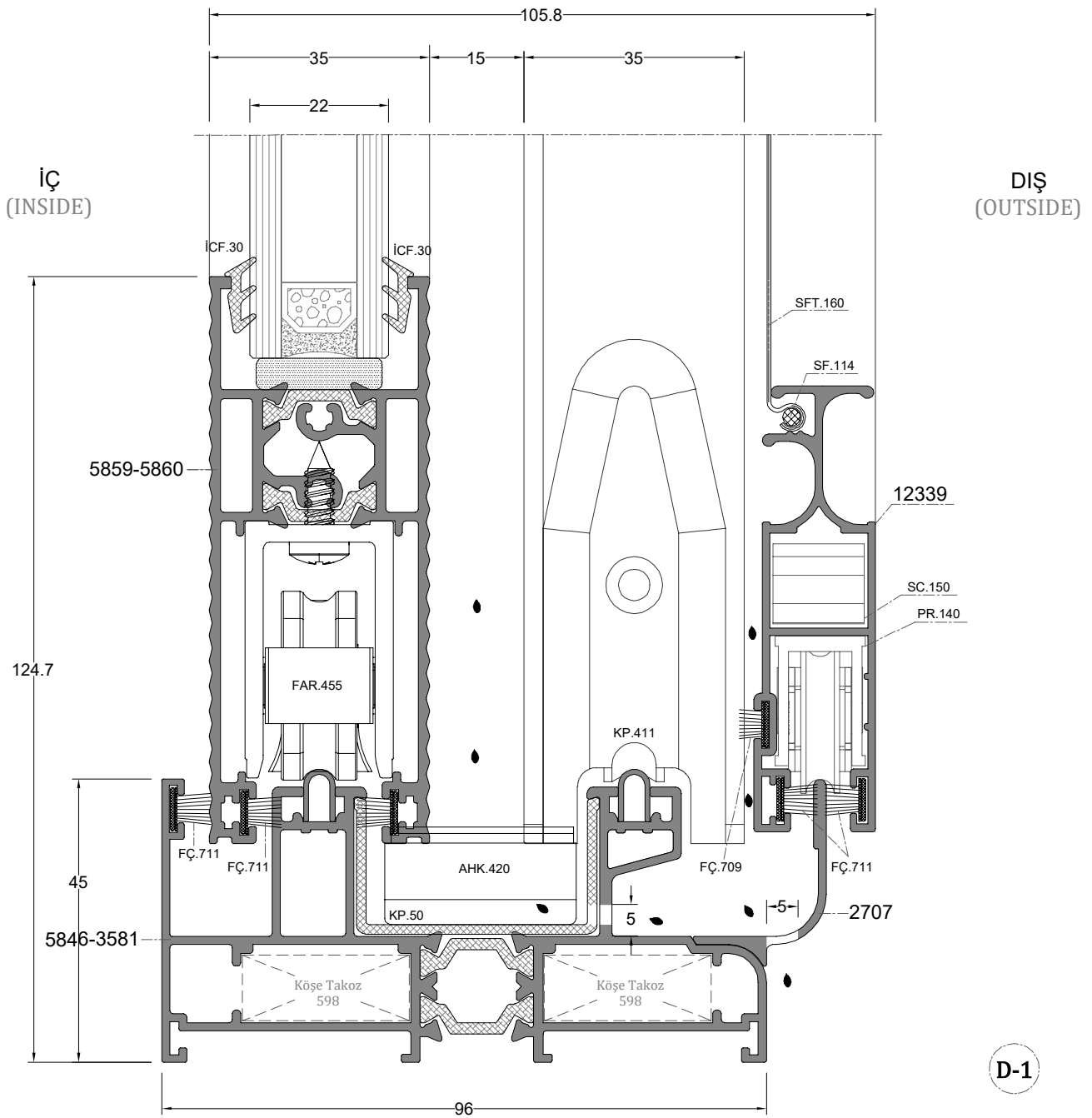
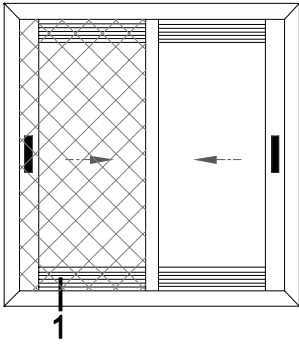

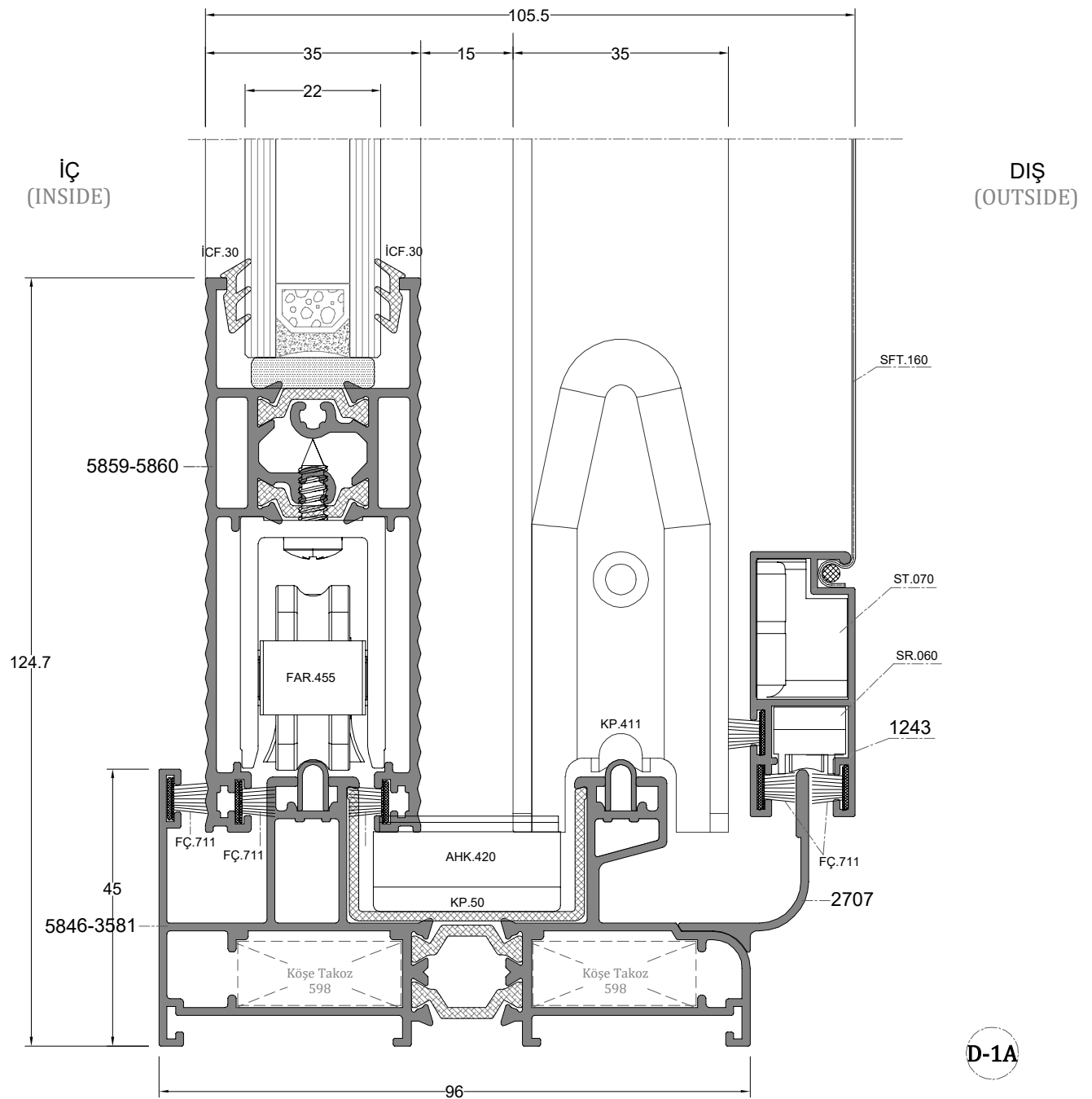
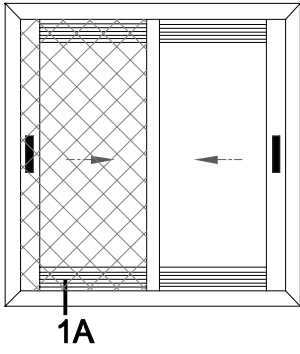

D-1A

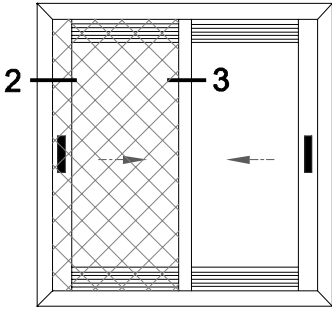

İÇ
(INSIDE)

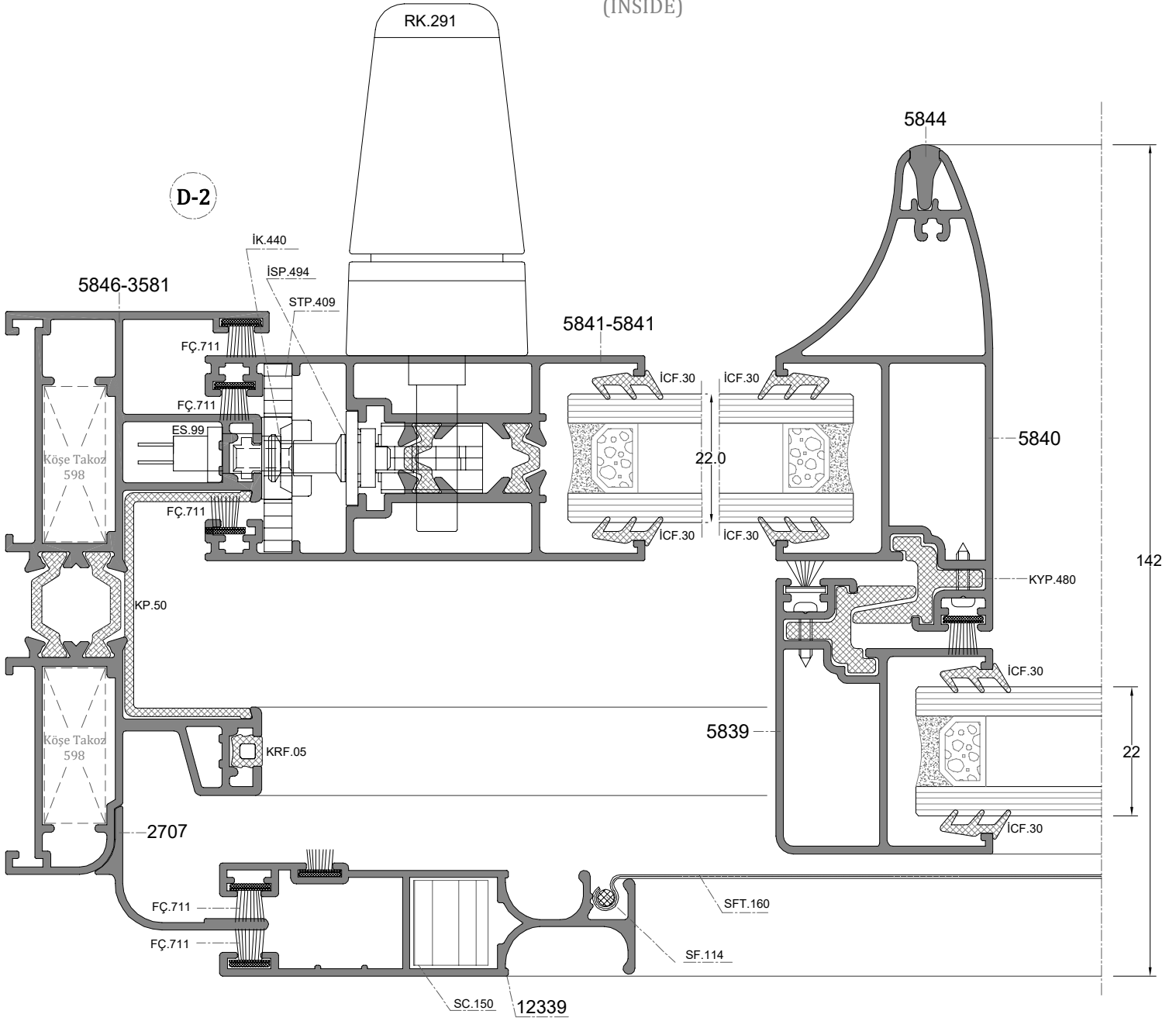

DIŞ
(OUTSIDE)

D-3

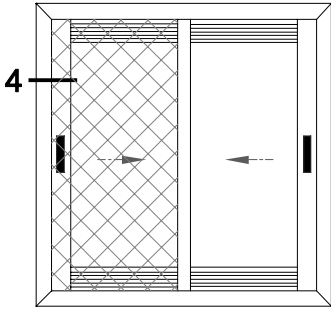

İÇ
(INSIDE)

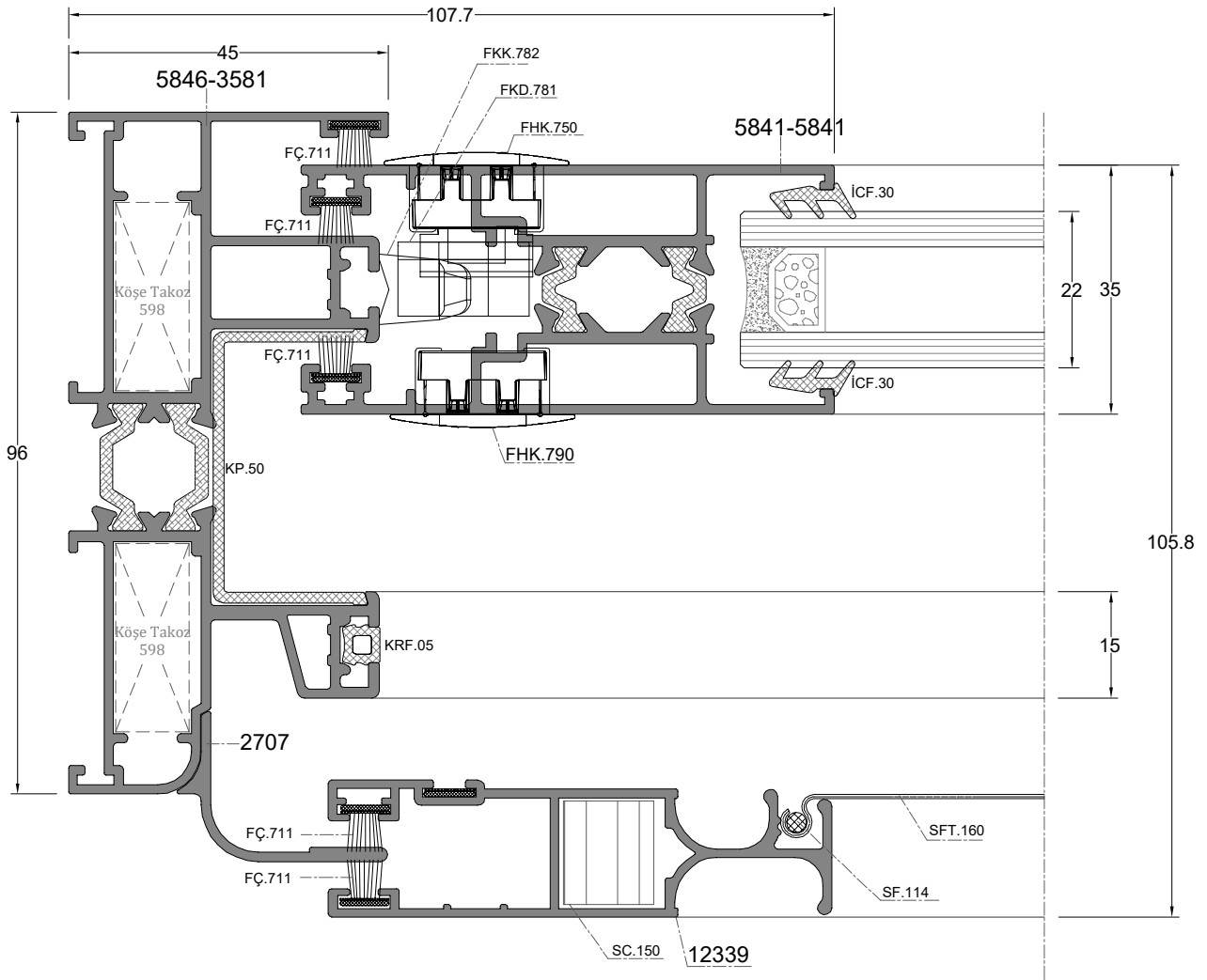

DIŞ
(OUTSIDE)

D-4

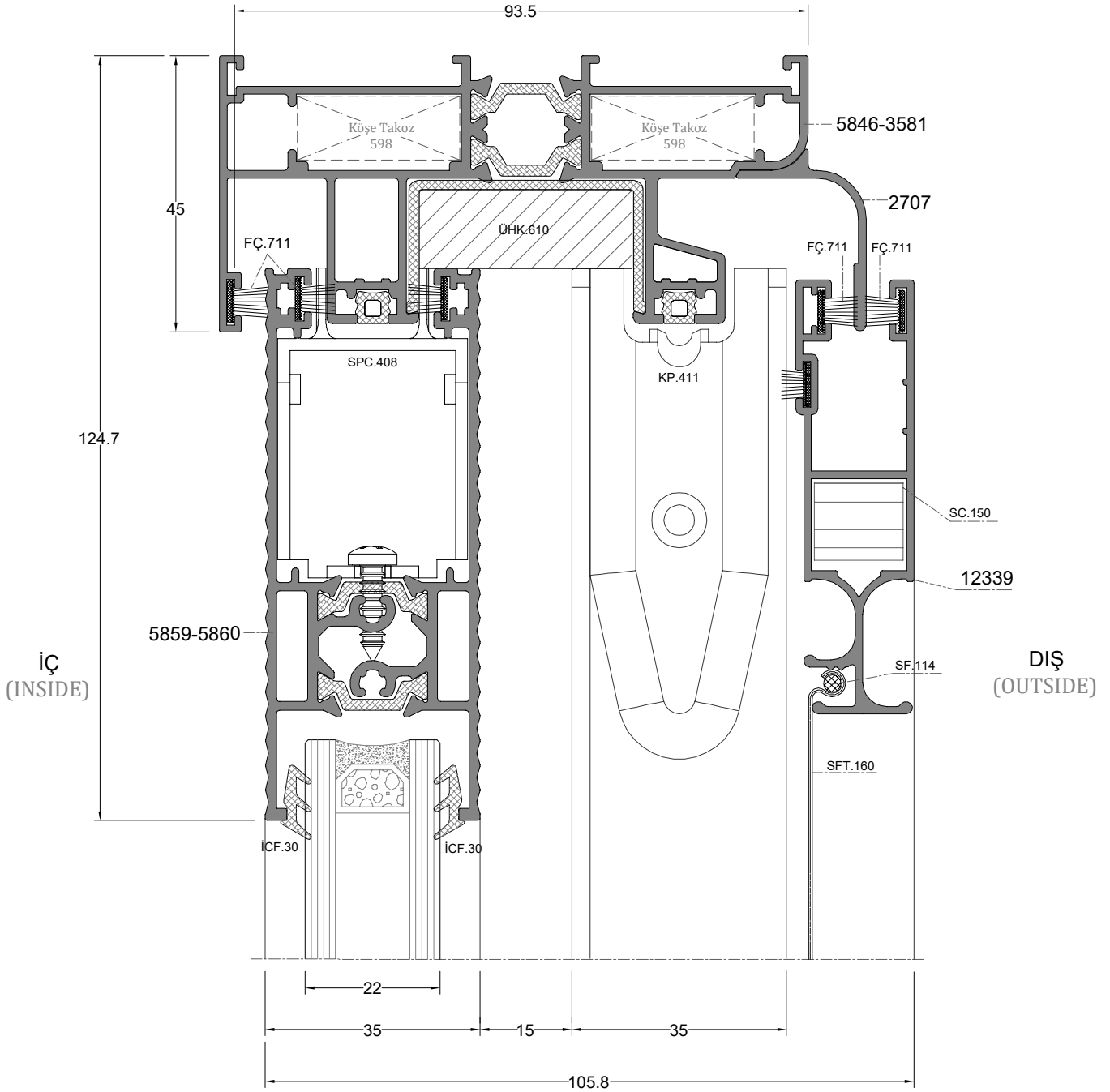
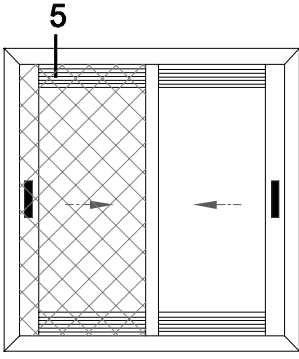

D-5

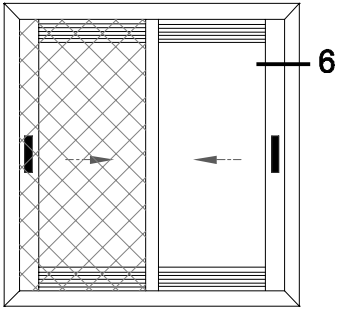

İÇ
(INSIDE)

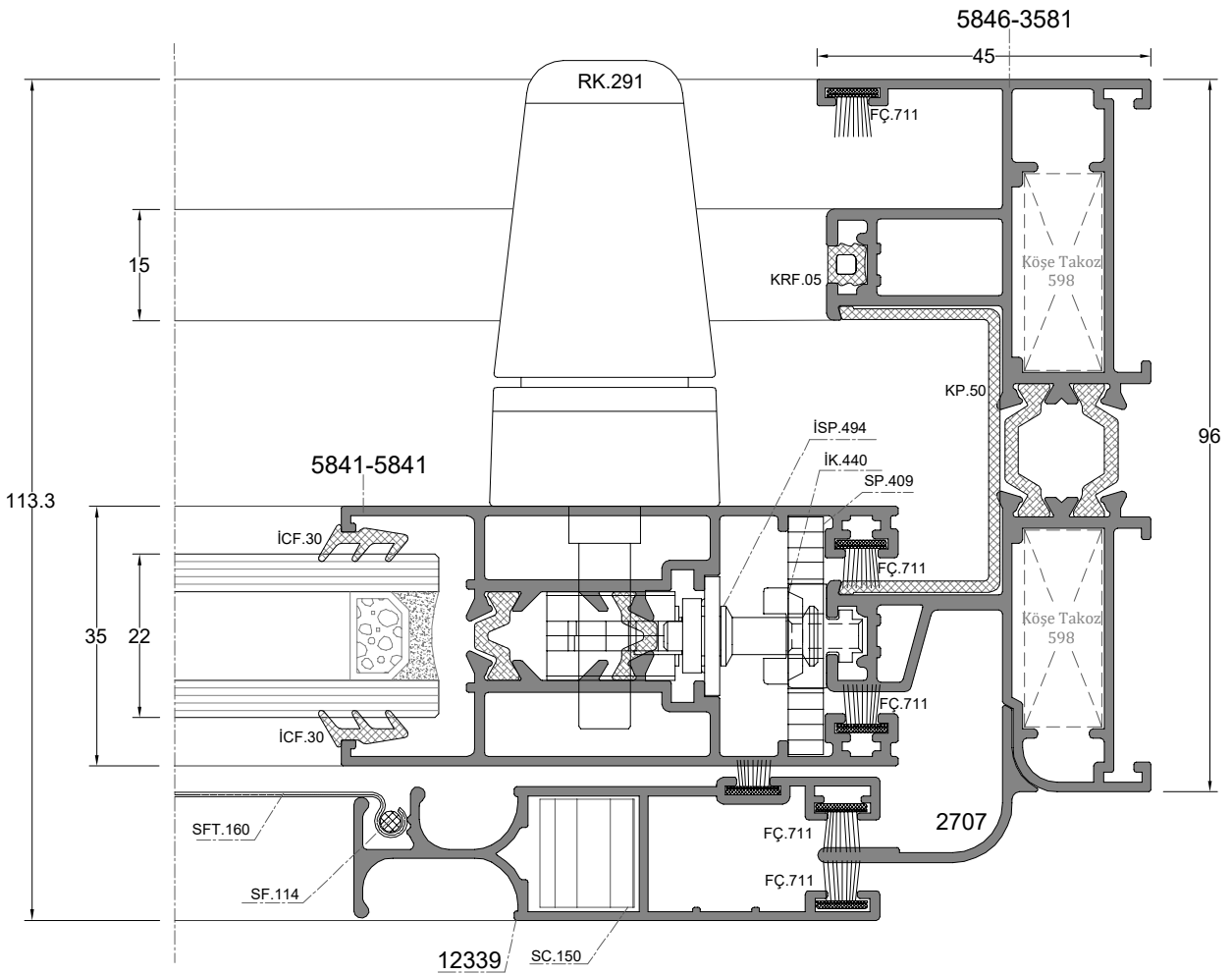

DIŞ
(OUTSIDE)

D-6

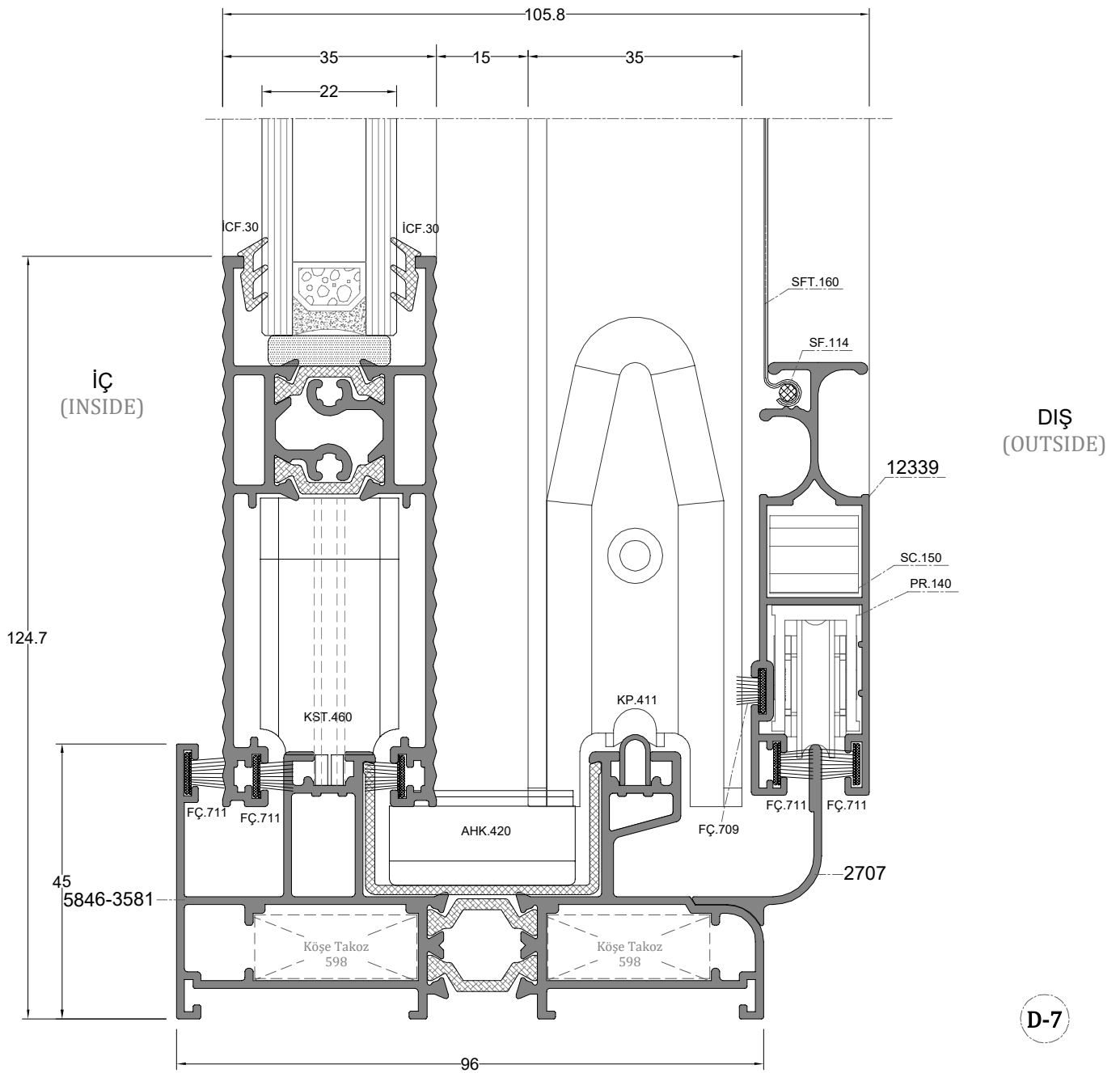
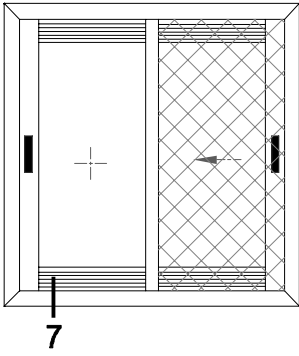

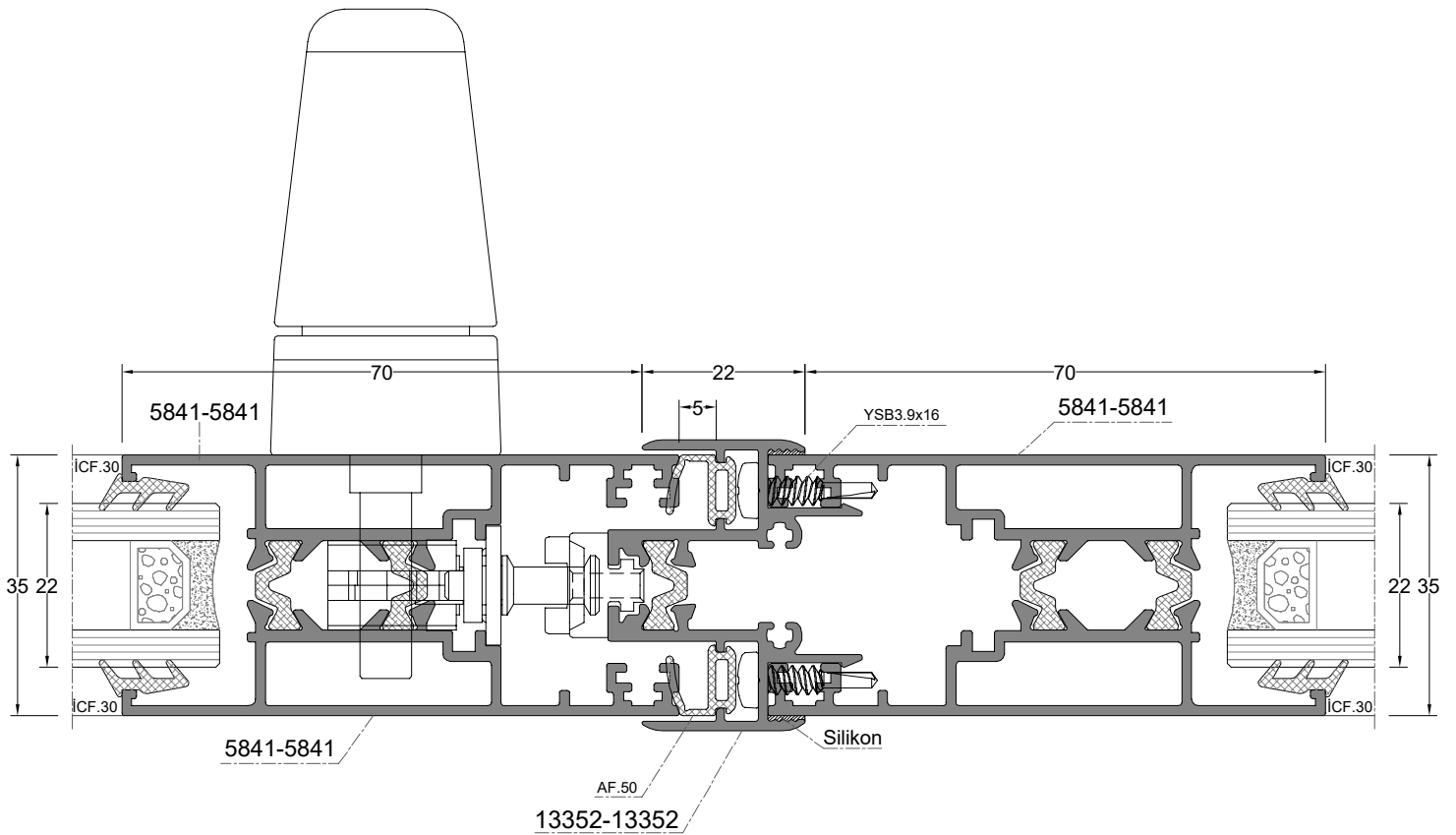
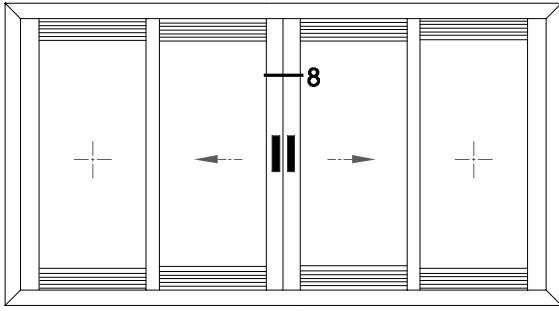

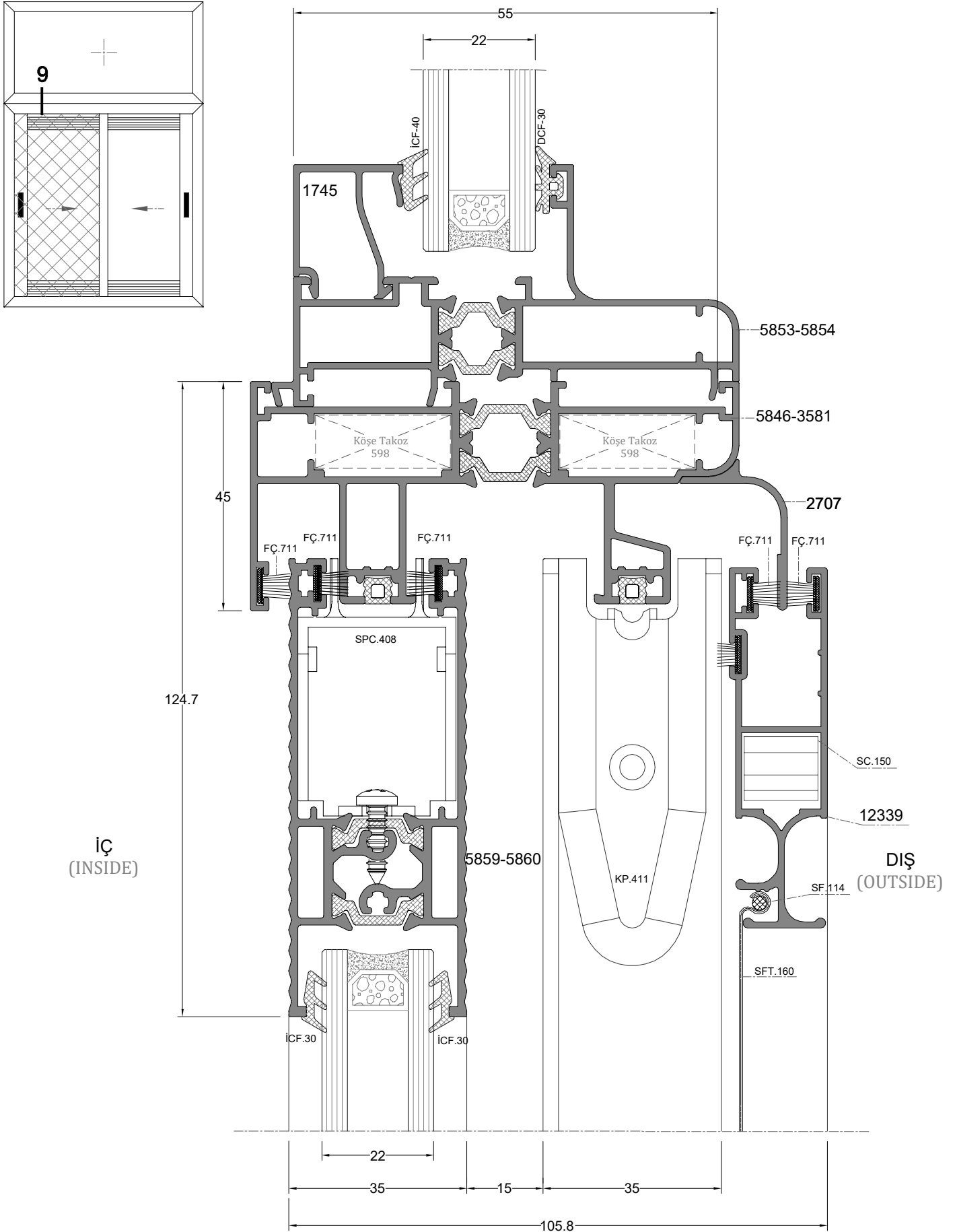

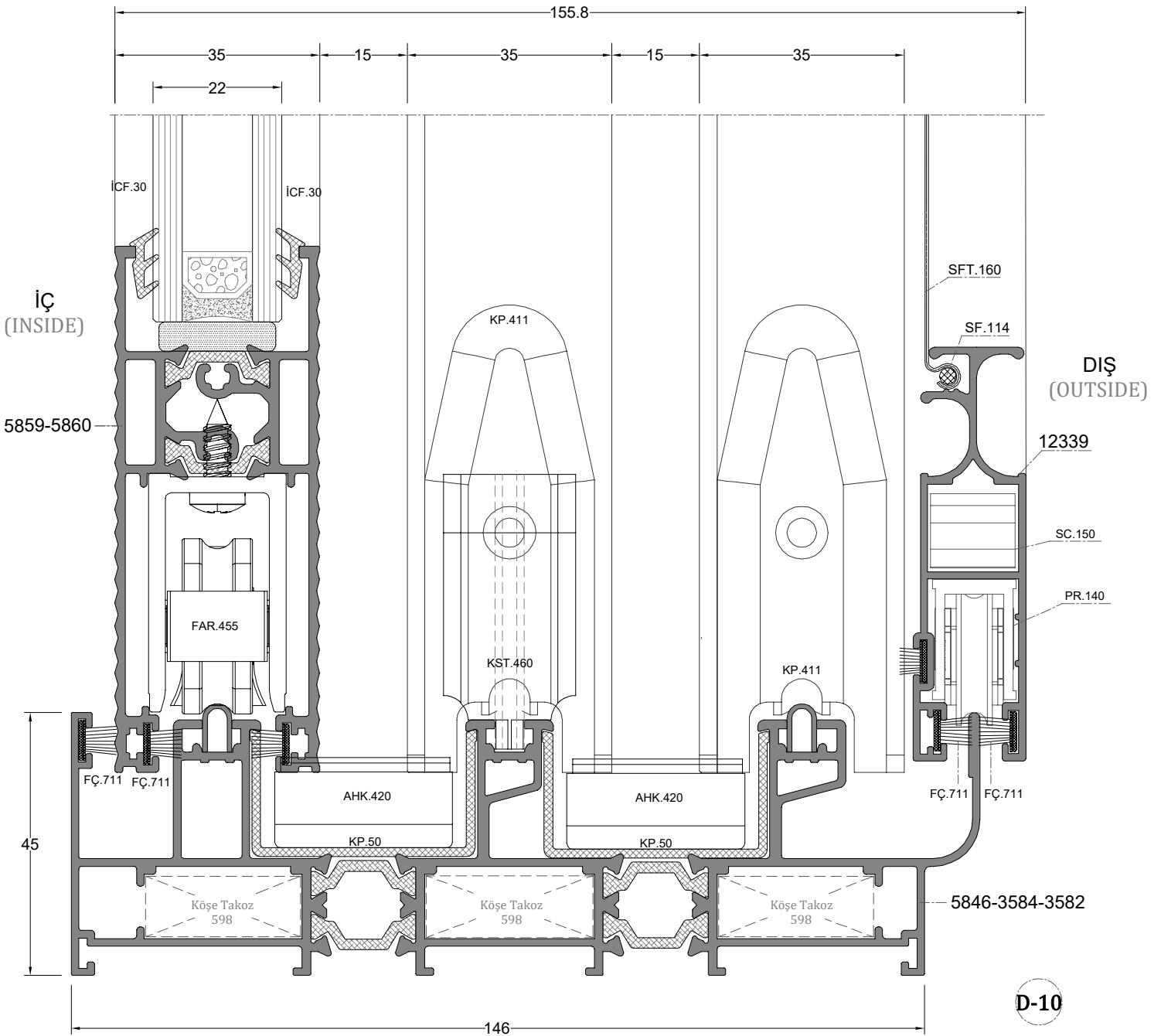
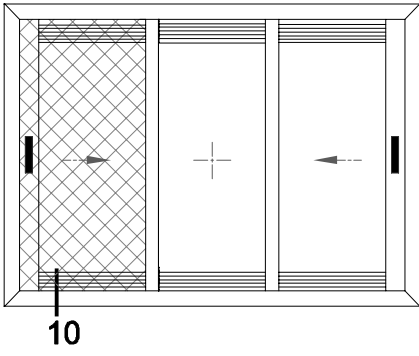

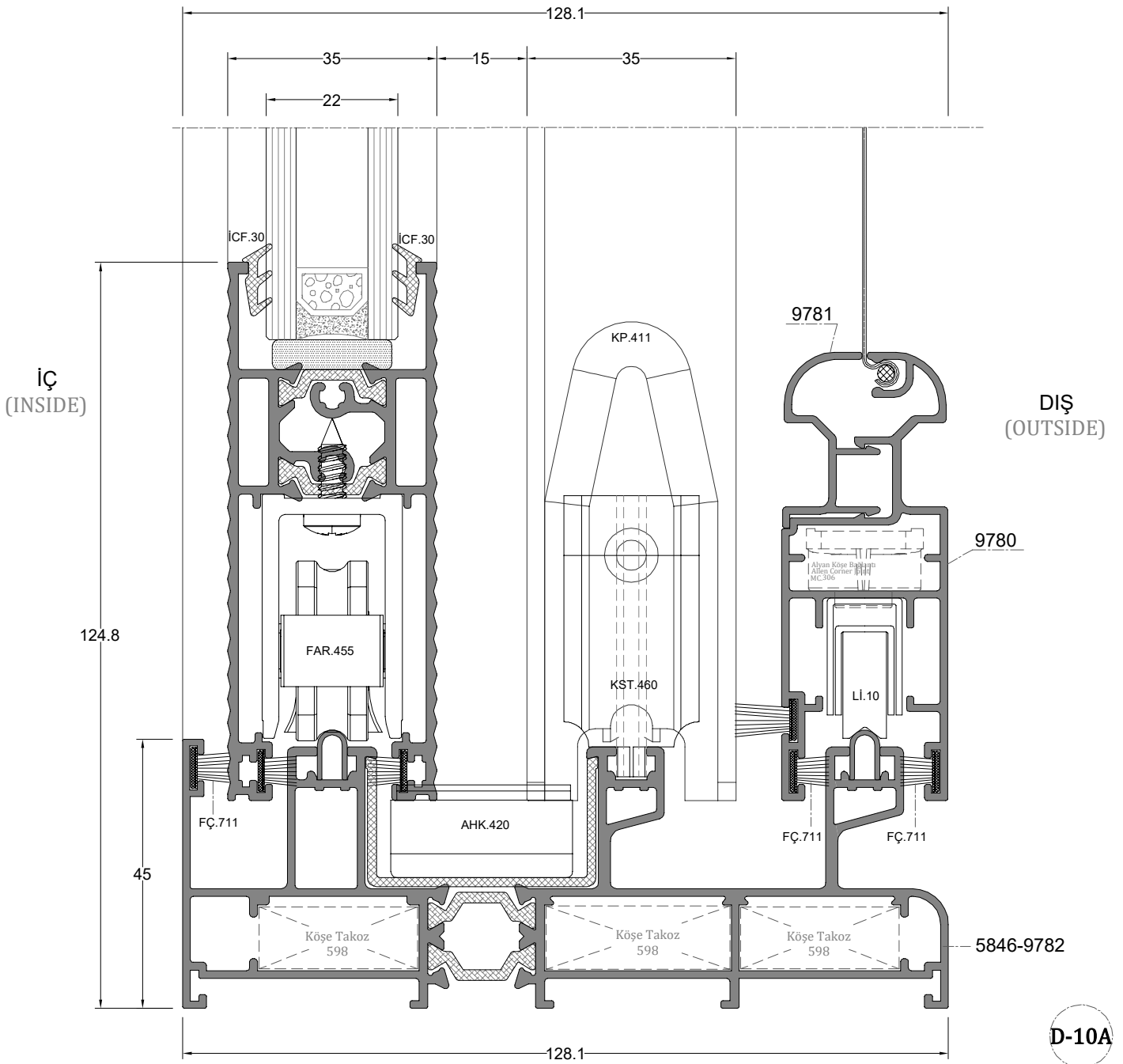
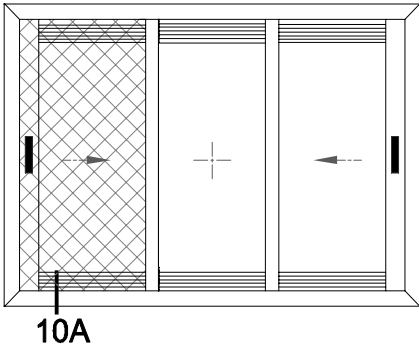

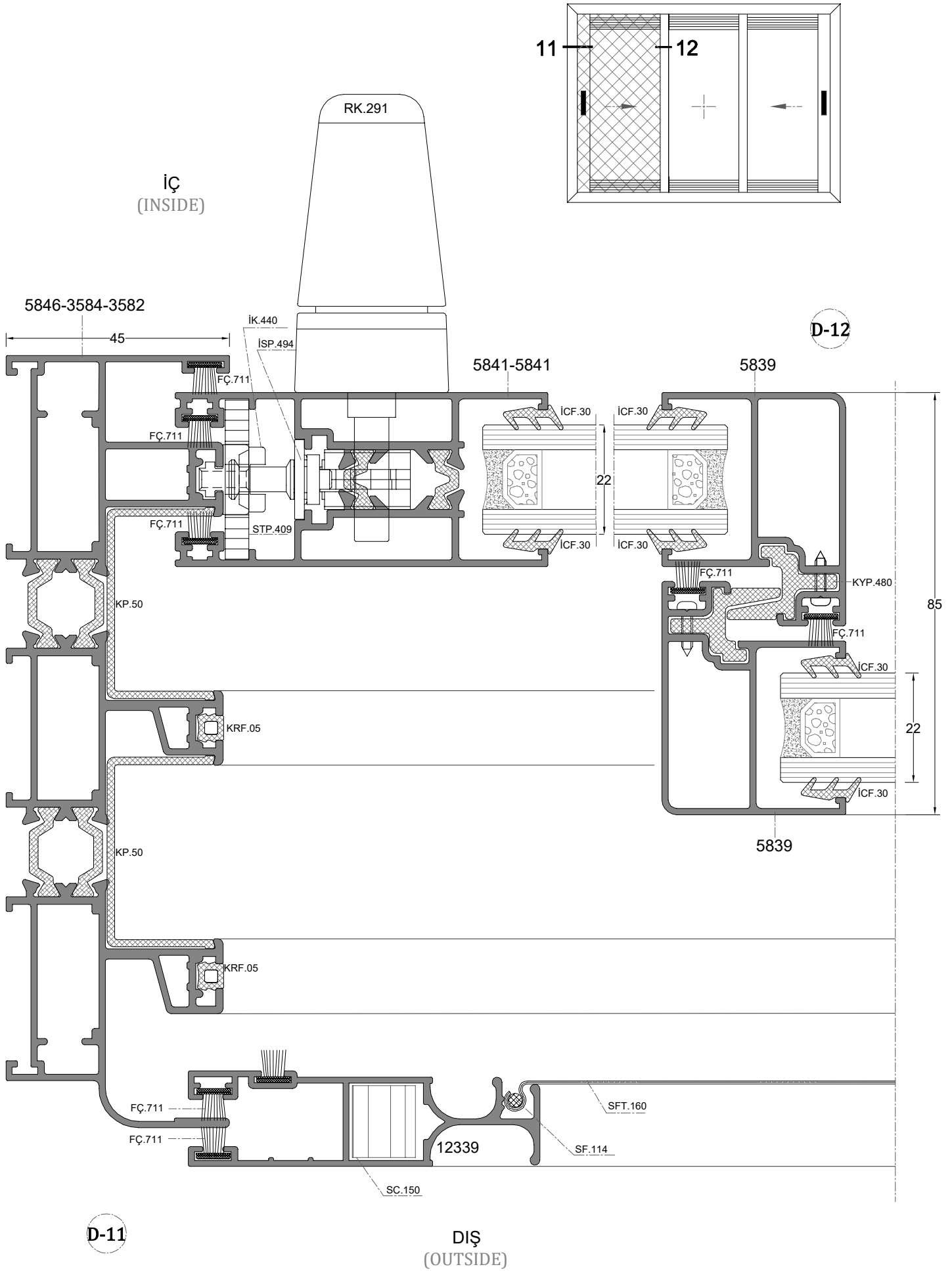

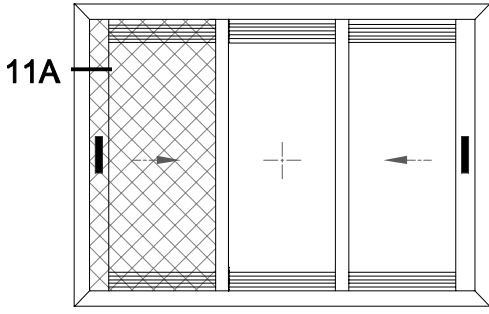

İÇ
(INSIDE)

D-11A

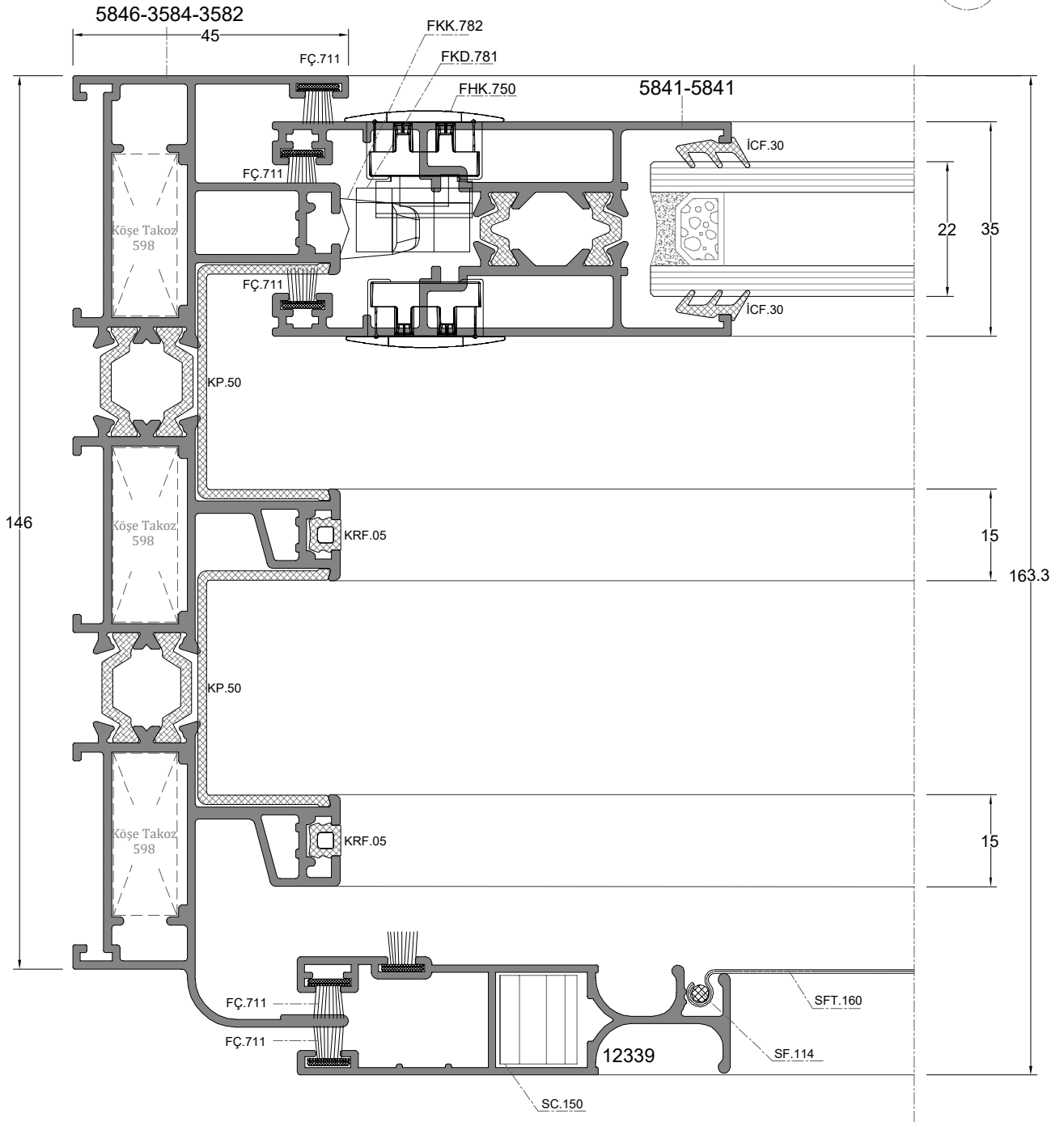

DIŞ
(OUTSIDE)

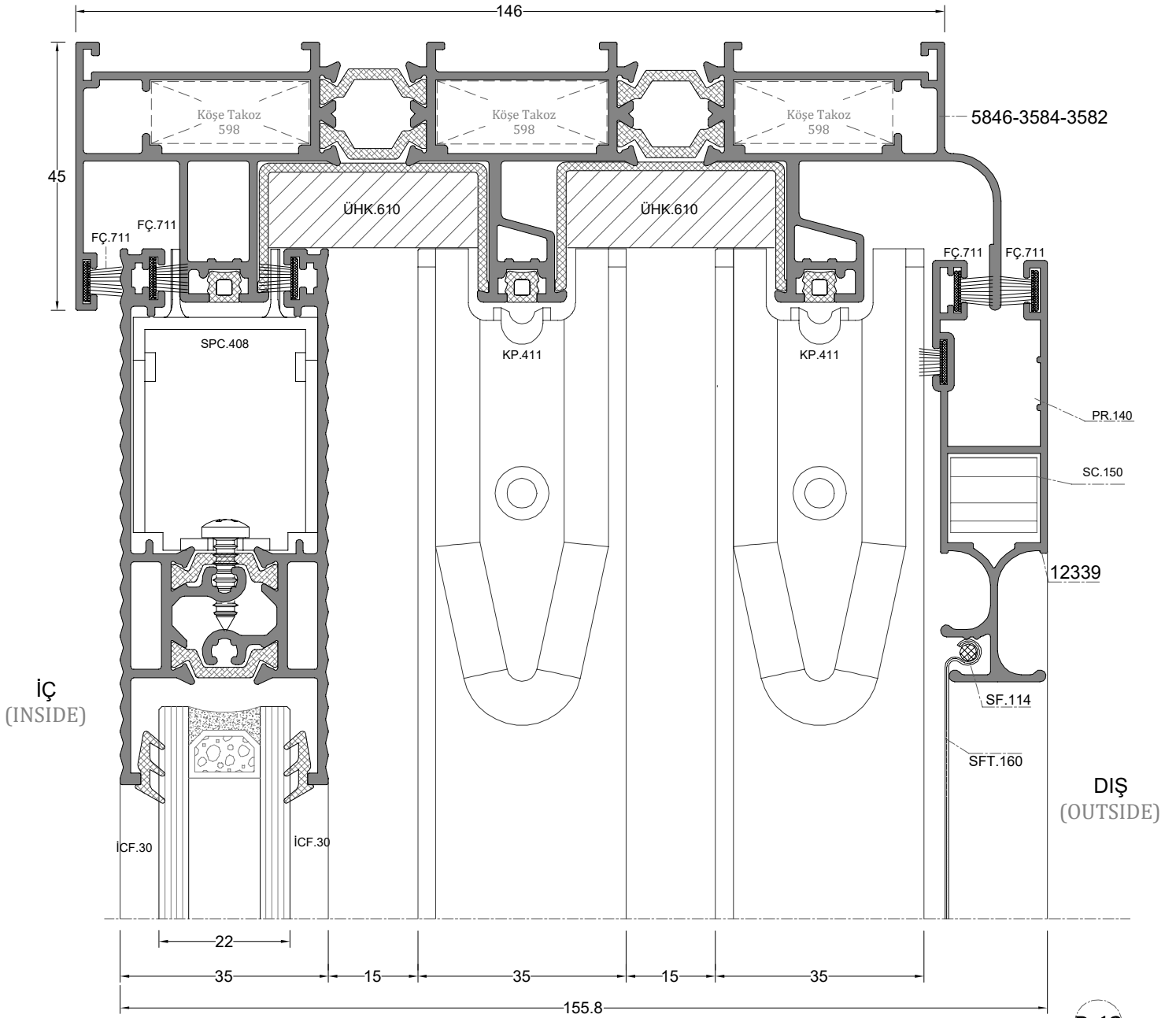
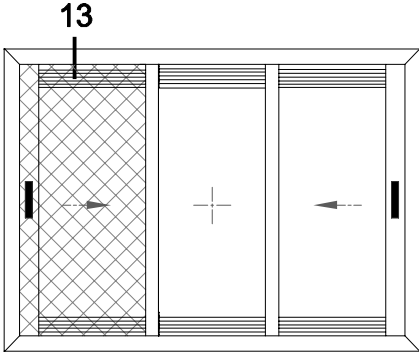

D-13

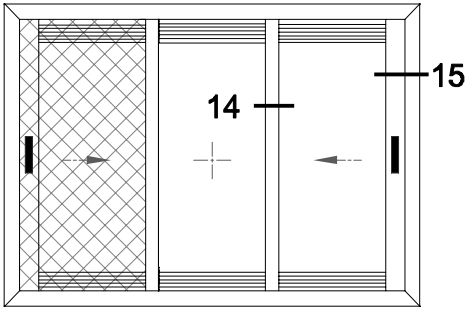

İÇ
(INSIDE)

D-14

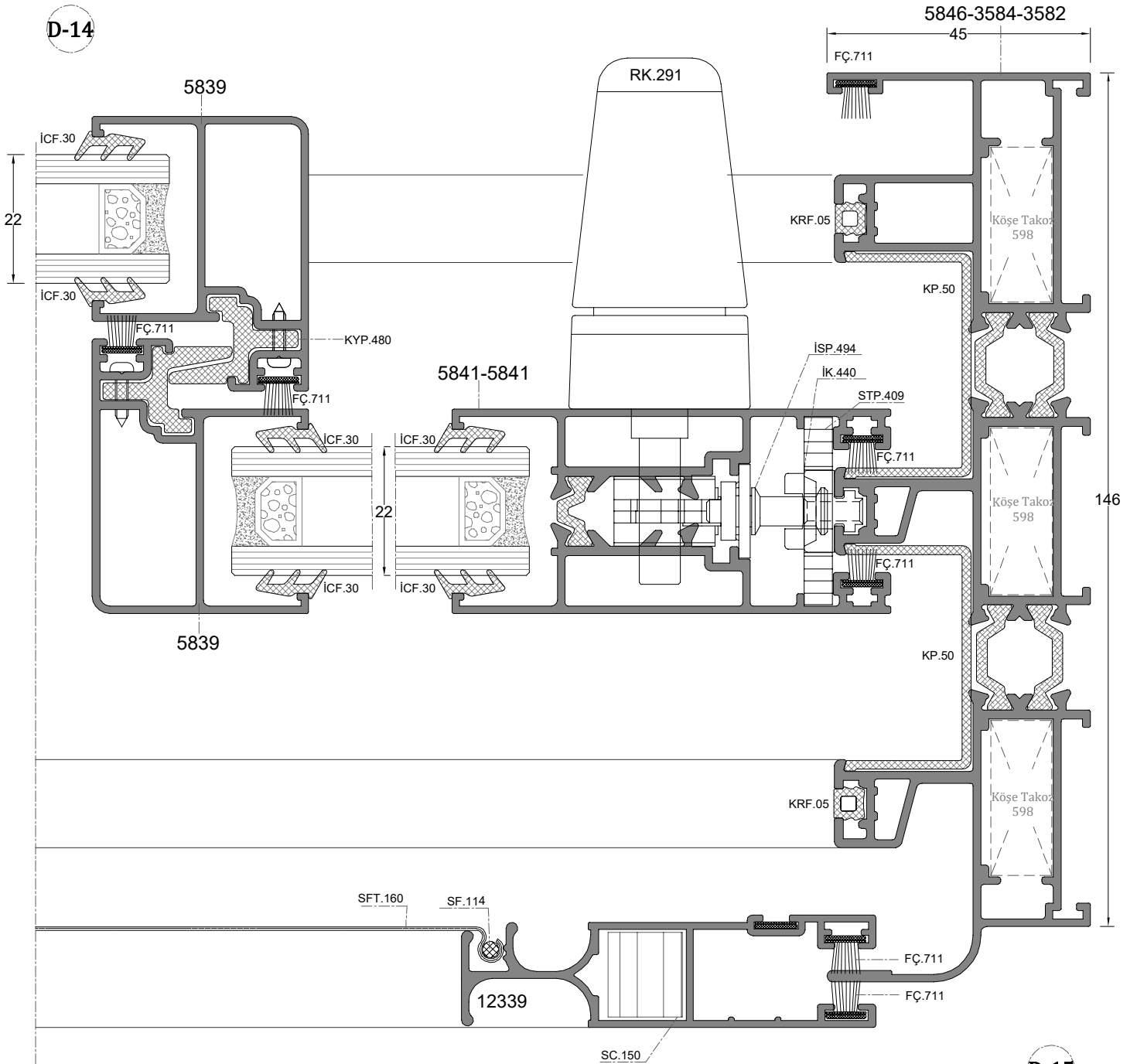

D-15

DIŞ
(OUTSIDE)

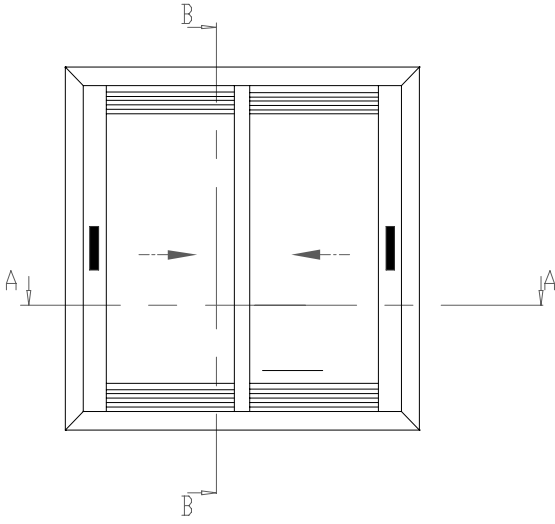

CAM ÖLÇÜLERİ EŞİT KABUL EDİLEREK
FORMULİZE EDİLMİŞTİR.

GLASS DIMENSIONS ARE
FORMULATED, ACCEPT EQUAL.

B-B KESİTİ

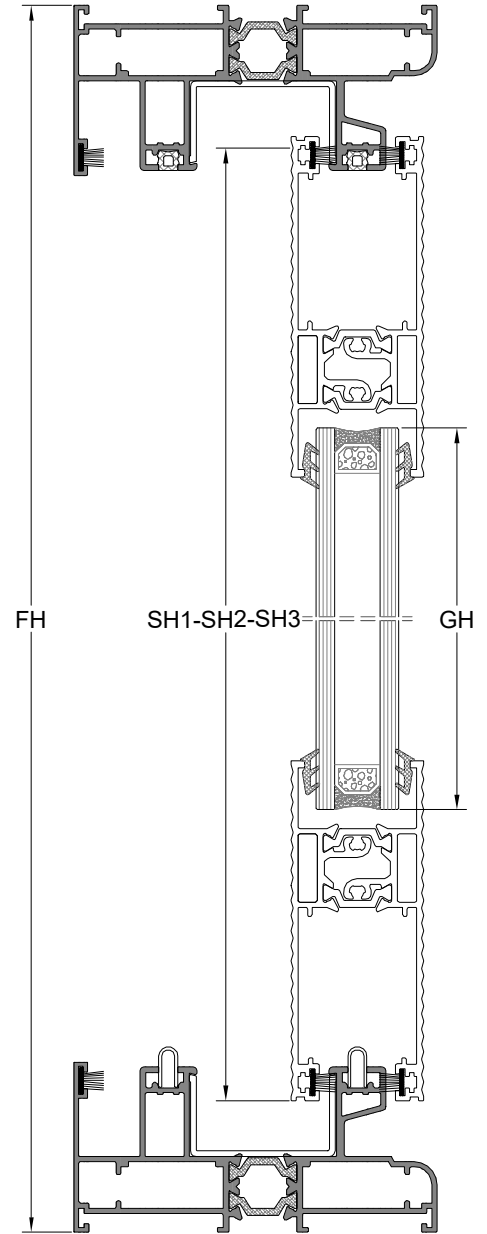

PROFİLLER / PROFILES

Kod Code	Çizim Drawing	Kesim Cut	Miktar Quantity	Ölçüler Dimensions
5846-3581 Kasa Frame			2 Pcs / Adet	FL
			2 Pcs / Adet	FH
5841-5841 Kanat Sash			2Pcs / Adet	SH1= FH-76
5839 Kanat Sash			1Pcs / Adet	SH2= FH-76
5840 Kanat Sash			1Pcs / Adet	SH3= FH-76
5859-5860 Kanat Sash			4Pcs / Adet	SL1= (FL/2)-132

CAM / GLASS

Kod Code	Çizim Drawing	Miktar Quantity	Ölçüler Dimensions
CAM GLASS		2 Pcs / Adet	GL1 = (FL/2)-100
			GH = FH-224

A-A KESİTİ

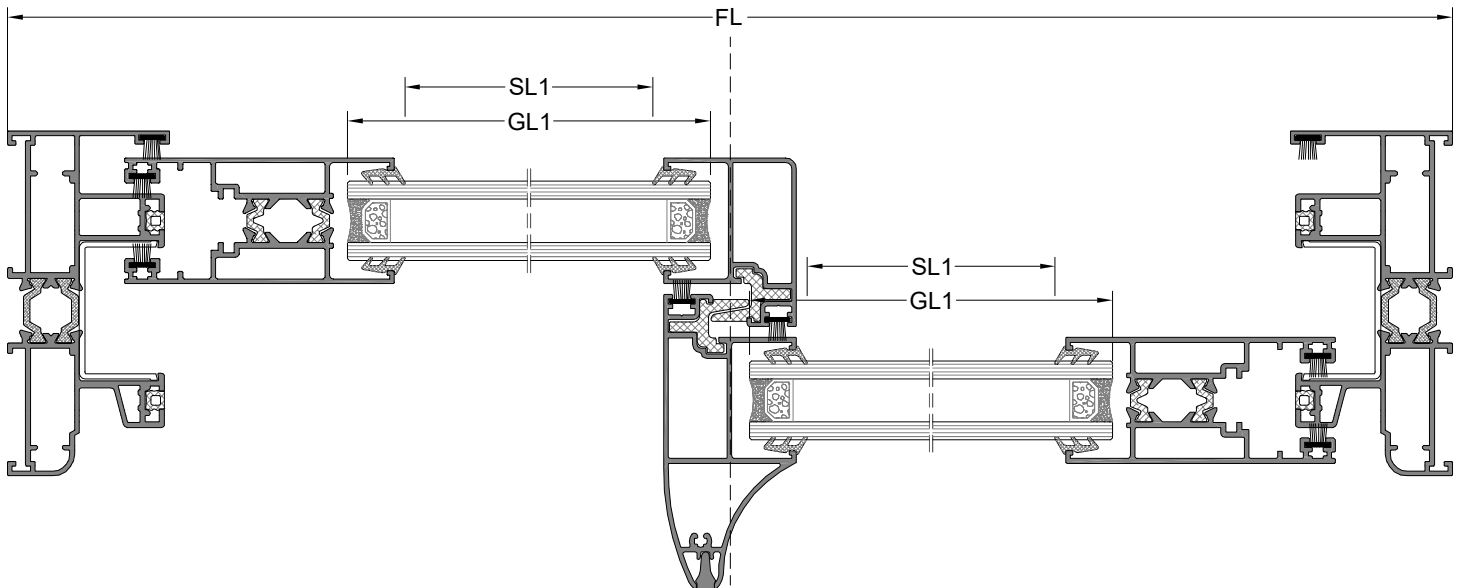

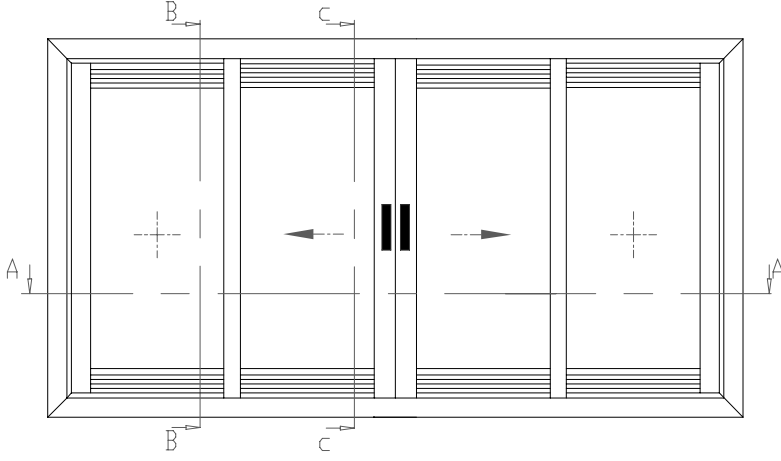

B-B KESİTİ

C-C KESİTİ

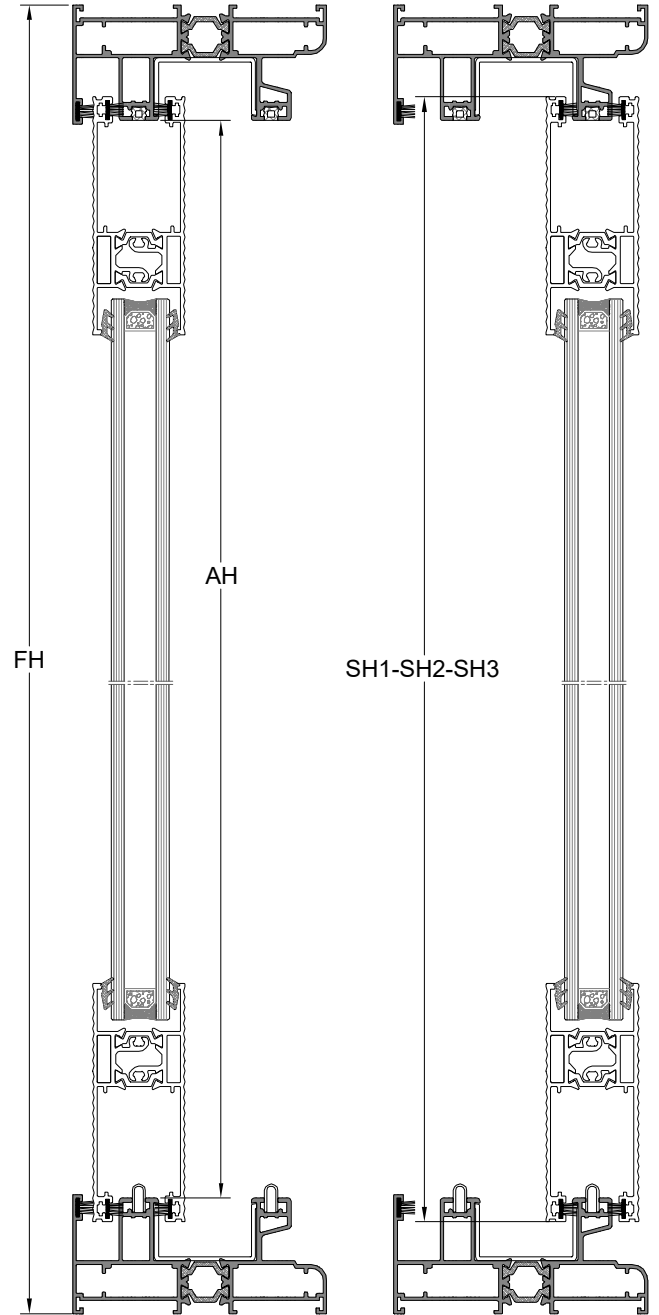

PROFİLLER / PROFILES

Kod Code	Çizim Drawing	Kesim Cut	Miktar Quantity	Ölçüler Dimensions
5822 Kasa Frame			2 Pcs / Adet	FL
			2 Pcs / Adet	FH
5833 Kanat Sash			4Pcs / Adet	SH1= FH-76
5830 Kanat Sash			2Pcs / Adet	SH2= FH-76
5831 Kanat Sash			2Pcs / Adet	SH3= FH-76
5825 Kanat Sash			8Pcs / Adet	SL1= (FL/4)-117
5825 Kanat Sash			1Pcs / Adet	AH= FH-95

CAM / GLASS

Kod Code	Çizim Drawing	Miktar Quantity	Ölçüler Dimensions
CAM GLASS		4 Pcs / Adet	GL1 = (FL/4)-85
			GH = FH-222

CAM ÖLÇÜLERİ EŞİT KABUL EDİLEREK
FORMULİZE EDİLMİŞTİR.

GLASS DIMENSIONS ARE
FORMULATED, ACCEPT EQUAL.

A-A KESİTİ

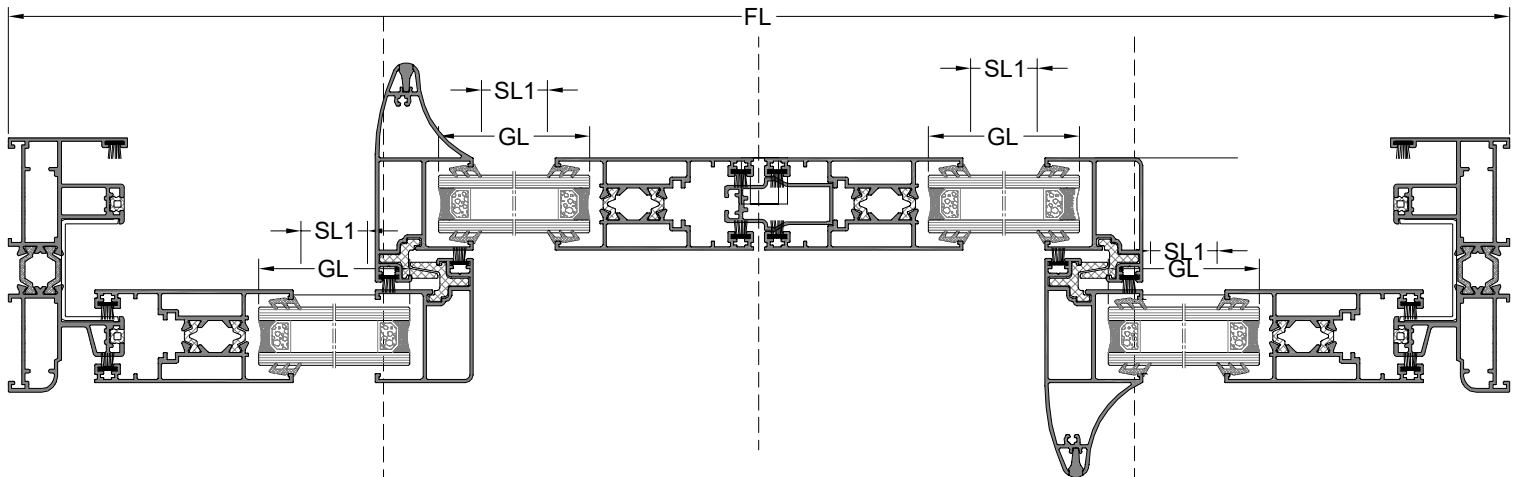



Sürme Sistem
Sliding System

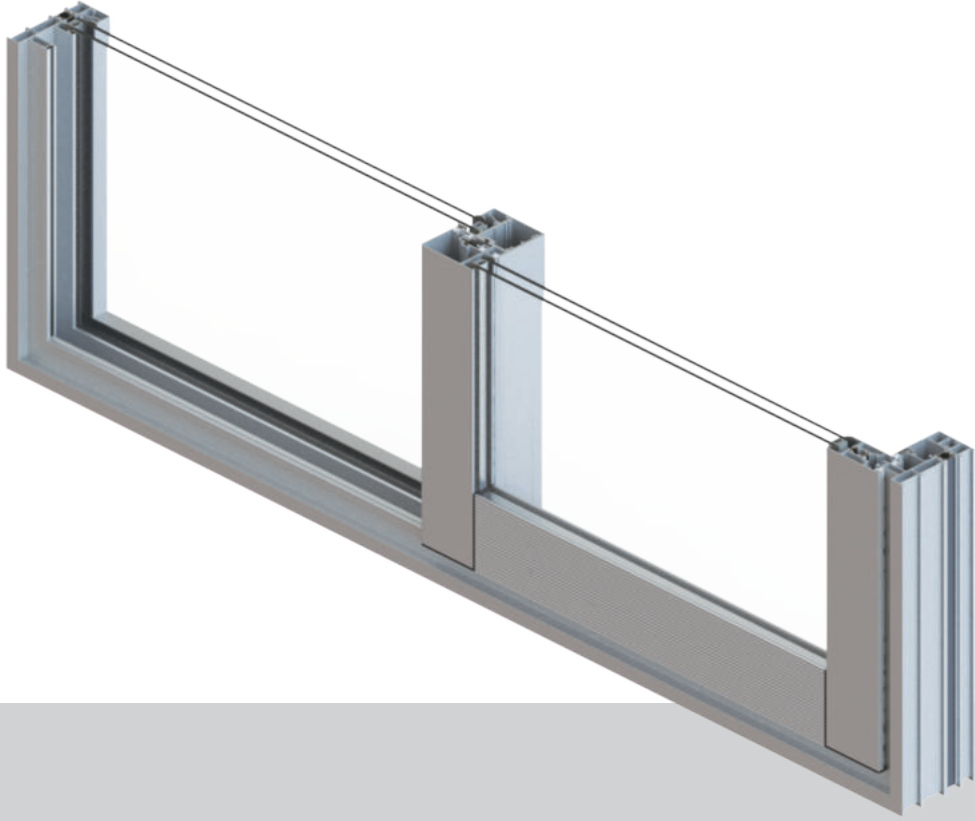

S35T

TEK RAYLI SİSTEM DETAYLARI
MONORAIL SYSTEM DETAILS



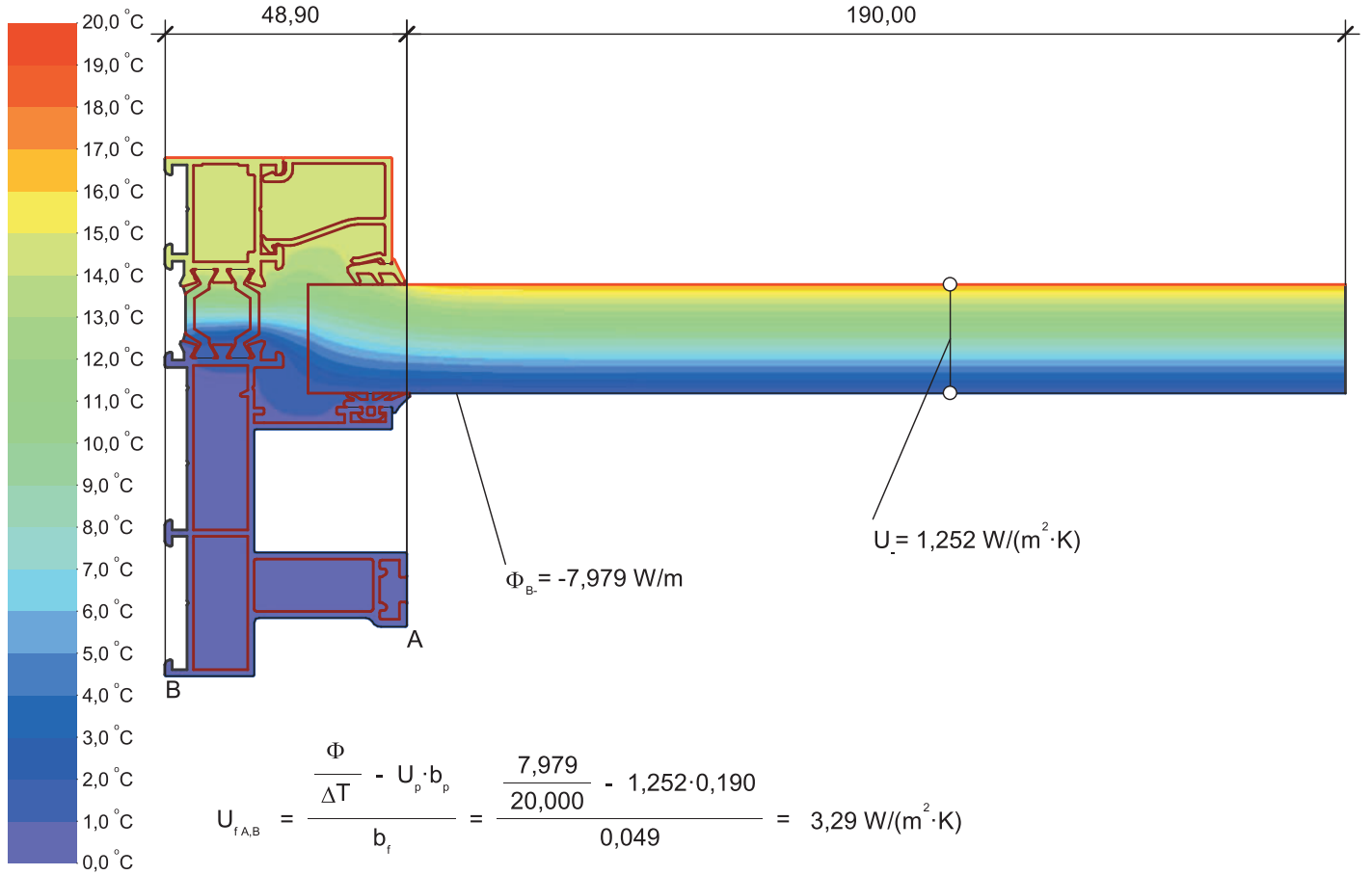

Material	λ [W/(m·K)]	ϵ	Boundary Condition	q [W/m ²]	θ [°C]	R [(m ² ·K)/W]	ϵ
Aluminium (Si Alloys)	160,000	0,900	Epsilon 0.9				0,900
EPDM (ethylene propylene diene monomer)	0,250	0,900	Exterior, frame	0,000	0,040		
Panel	0,035	0,900	Interior, normal, horizontal	20,000	0,130		
Polyamid 6.6 with 25% glass fibre	0,300	0,900	Symmetry/Model section	0,000			
Slightly ventilated air cavity	anisotropic						
Unventilated air cavity	anisotropic						

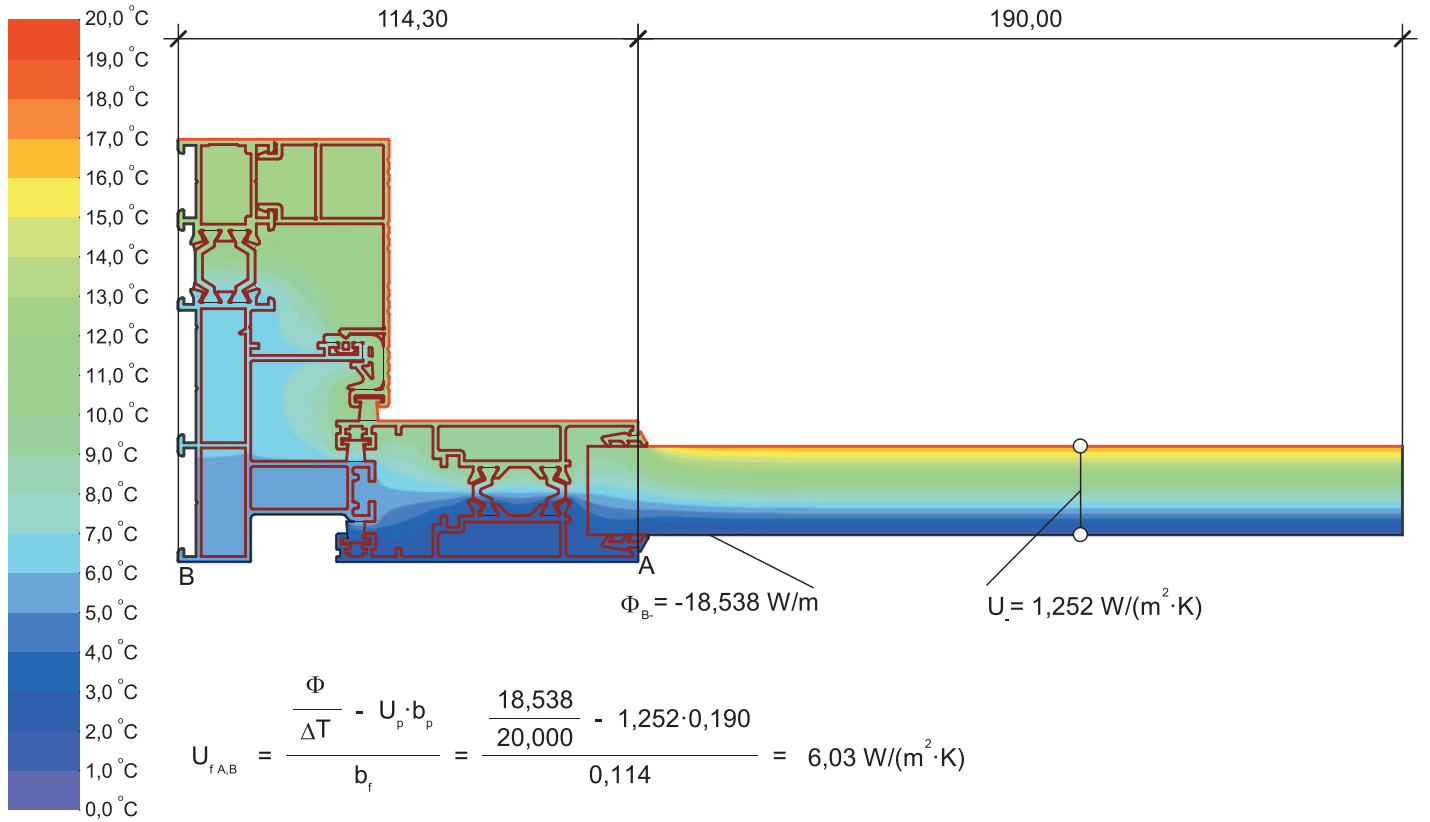

Material	λ [W/(m·K)]	ε	Boundary Condition	q [W/m ²]	θ [°C]	R [(m ² ·K)/W]	ε
Aluminium (Si Alloys)	160,000	0,900	Epsilon 0.9				0,900
EPDM (ethylene propylene diene monomer)	0,250	0,900	Exterior, frame	0,000	0,040		
Panel	0,035	0,900	Interior, normal, horizontal	20,000	0,130		
Polyamid 6.6 with 25% glass fibre	0,300	0,900	Symmetry/Model section	0,000			
Unventilated air cavity	anisotropic						

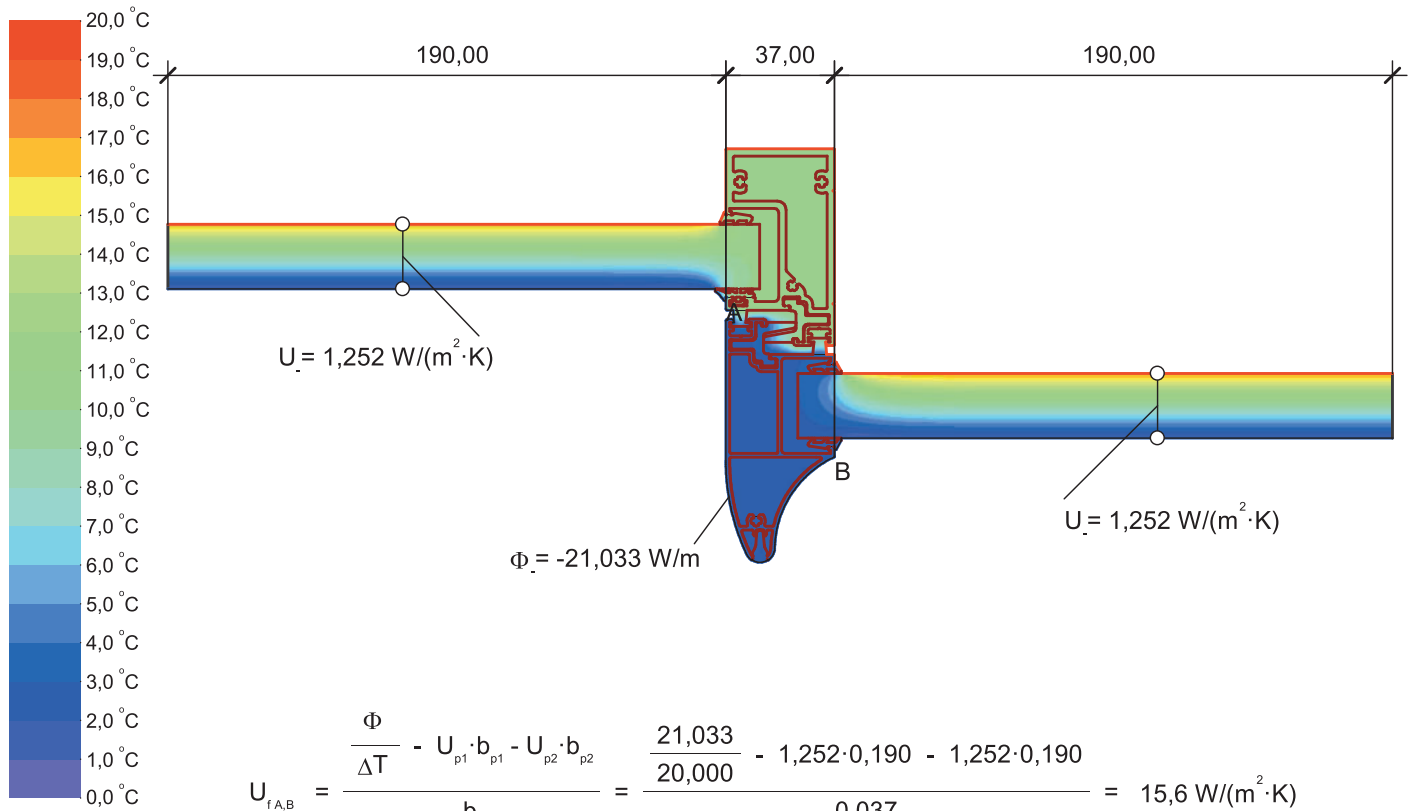

Material	λ [W/(m·K)]	ϵ	Boundary Condition	q [W/m ²]	θ [°C]	R [(m ² ·K)/W]	ϵ
Aluminium (Si Alloys)	160,000	0,900	Epsilon 0.9				0,900
EPDM (ethylene propylene diene monomer)	0,250	0,900	Exterior, frame	0,000	0,040		
Panel	0,035	0,900	Interior, normal, horizontal	20,000	0,130		
Polyamid 6.6 with 25% glass fibre	0,300	0,900	Symmetry/Model section	0,000			
Slightly ventilated air cavity	anisotropic						
Unventilated air cavity	anisotropic						

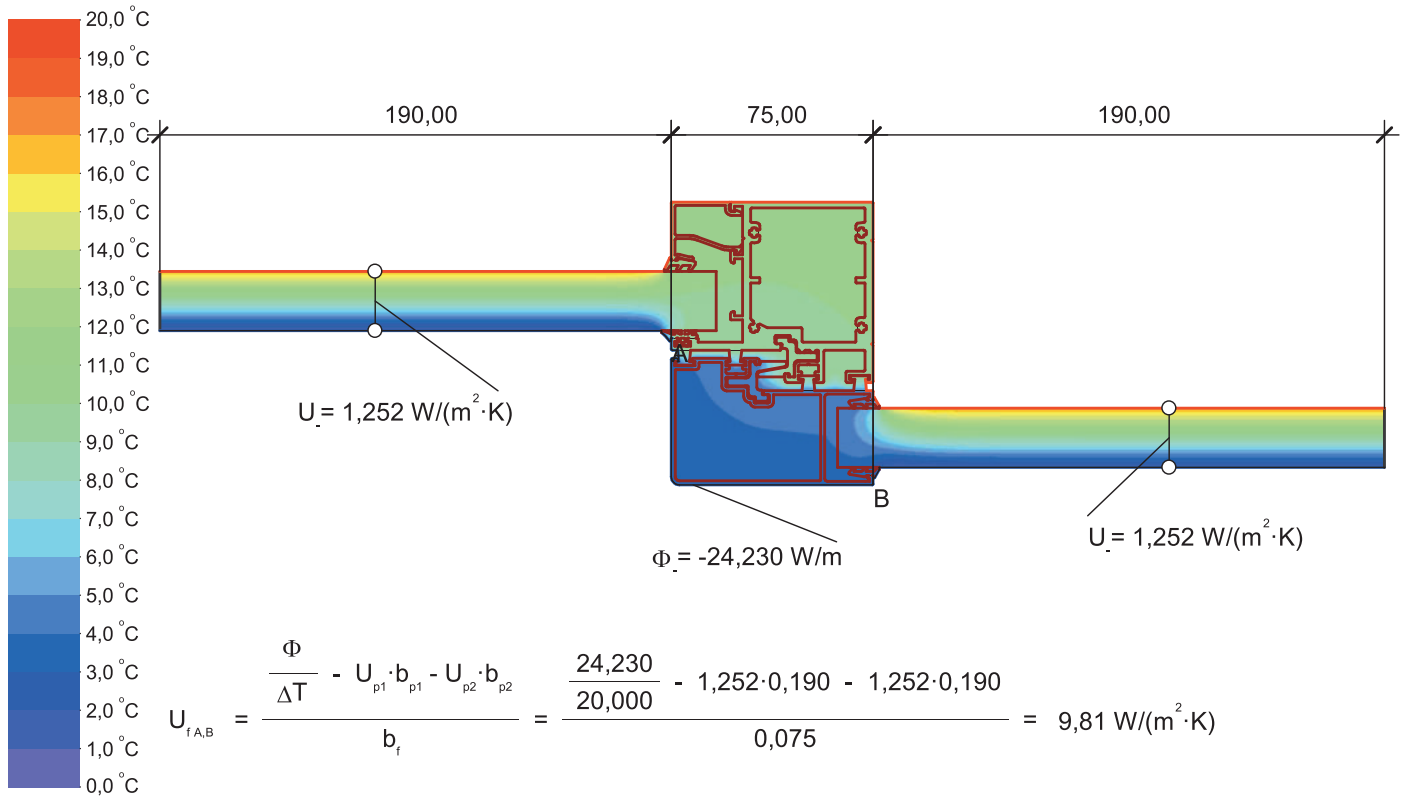

Material	λ [W/(m·K)]	ϵ	Boundary Condition	q [W/m ²]	θ [°C]	R [(m ² ·K)/W]	ϵ
Aluminium (Si Alloys)	160,000	0,900	Epsilon 0.9				0,900
EPDM (ethylene propylene diene monomer)	0,250	0,900	Exterior, frame	0,000	0,040		
Panel	0,035	0,900	Interior, normal, horizontal	20,000	0,130		
Polyamid 6.6 with 25% glass fibre	0,300	0,900	Symmetry/Model section	0,000			
Slightly ventilated air cavity	anisotropic						
Unventilated air cavity	anisotropic						

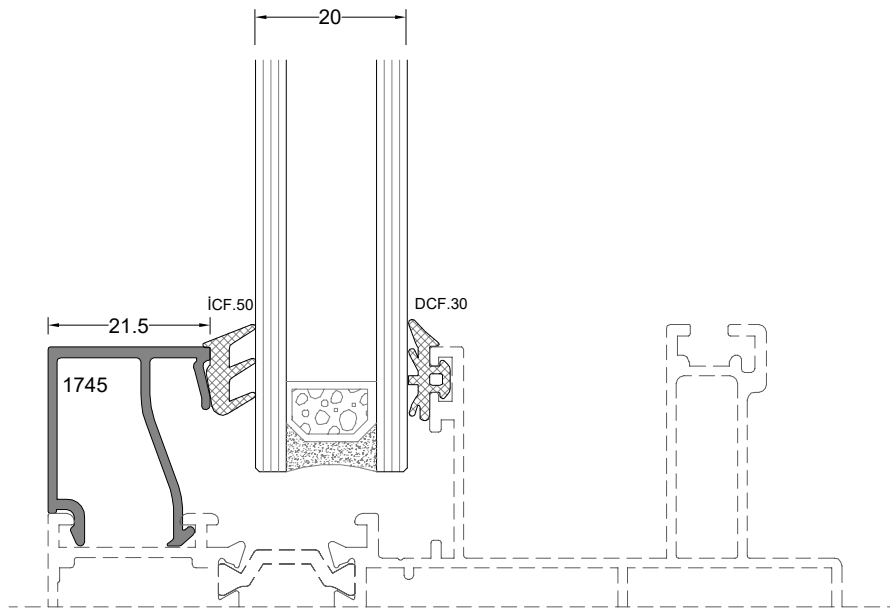
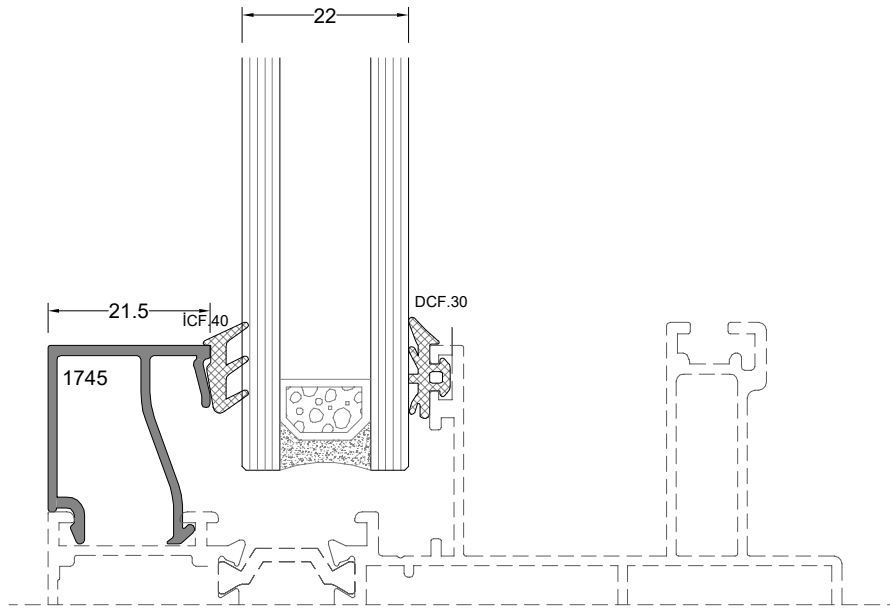

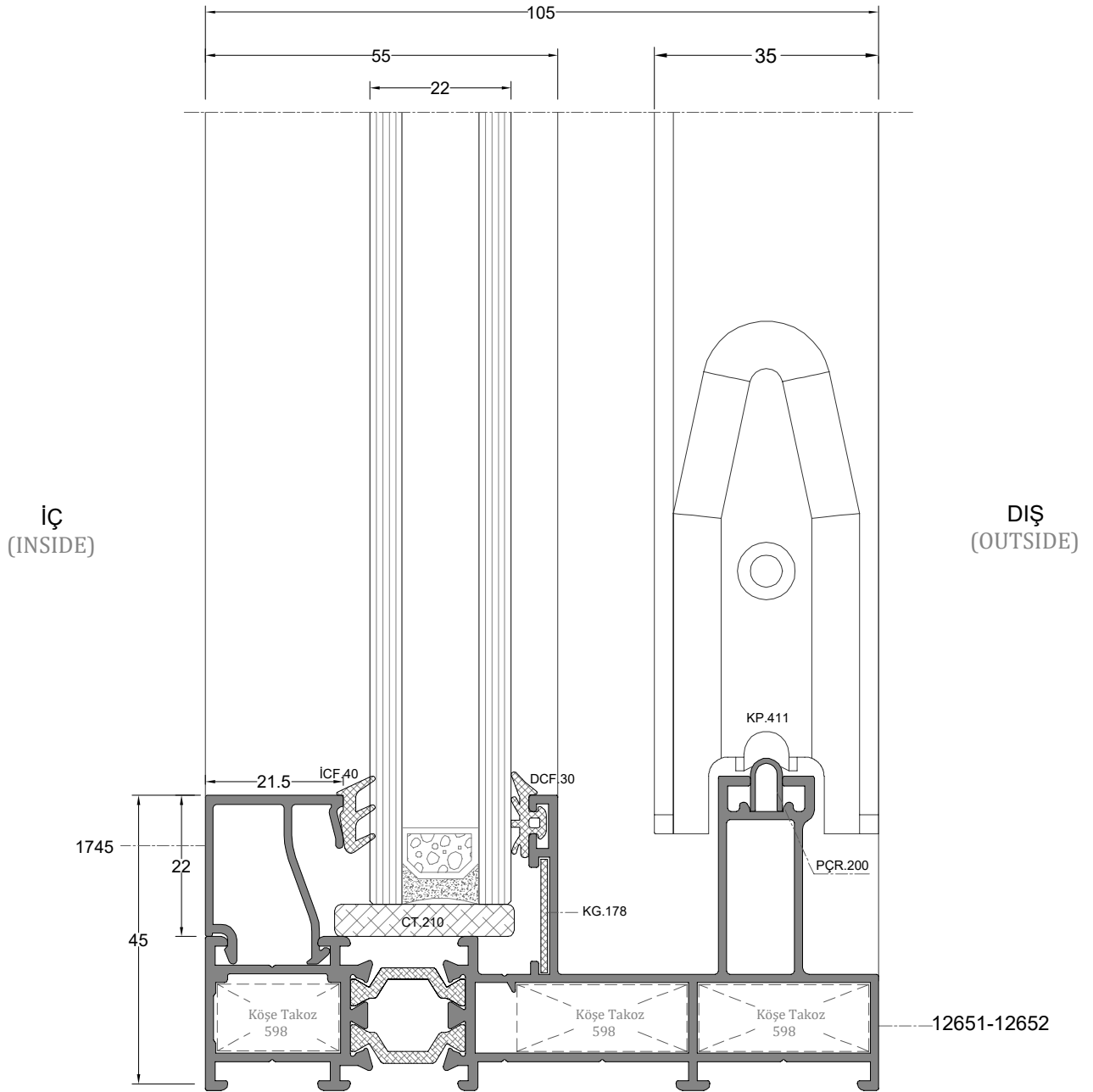
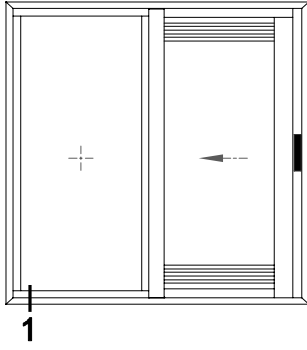

D-1

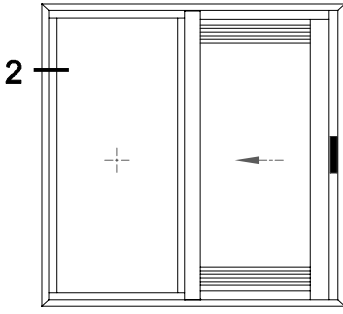

İÇ
(INSIDE)

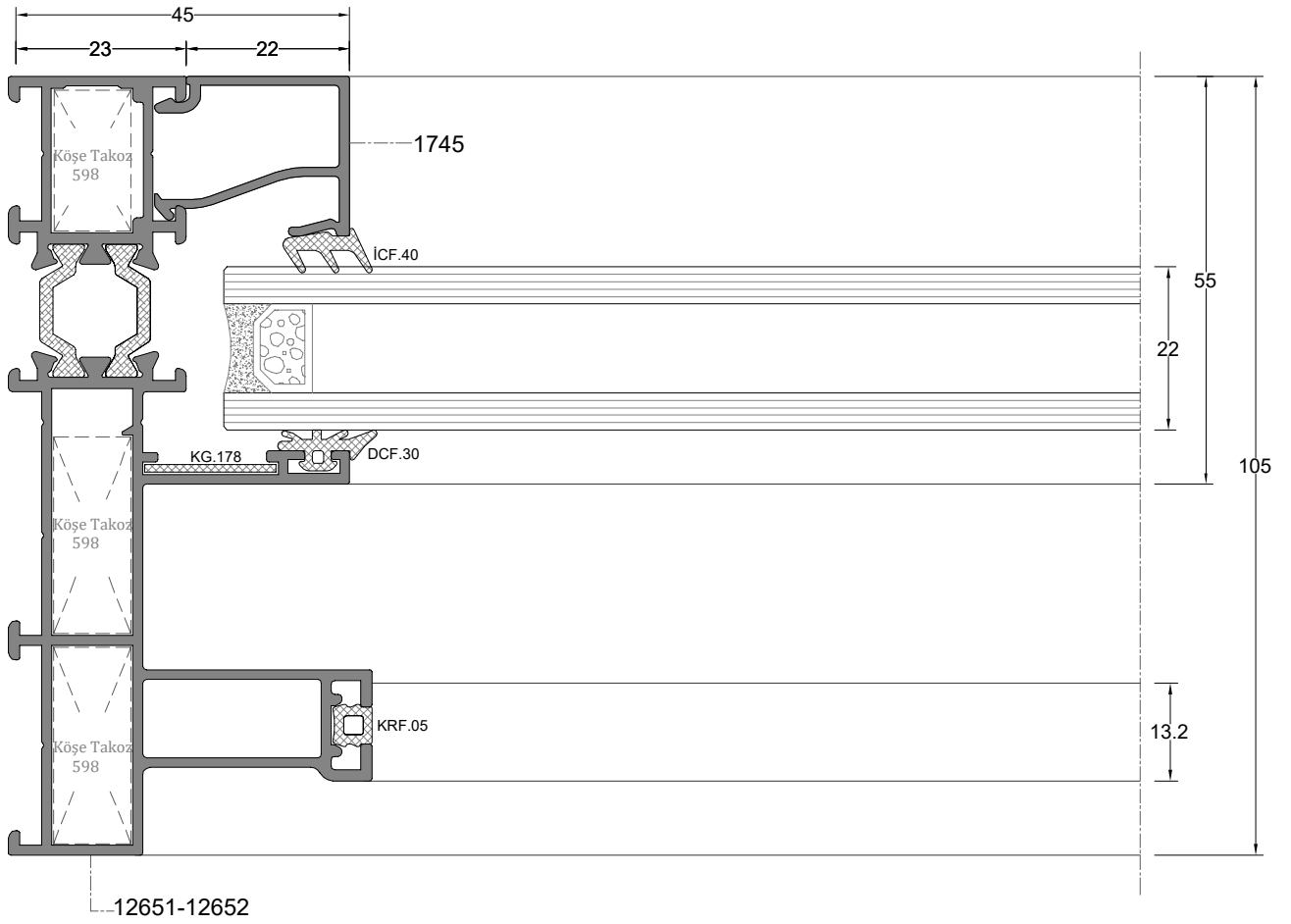

DIŞ
(OUTSIDE)

D-2

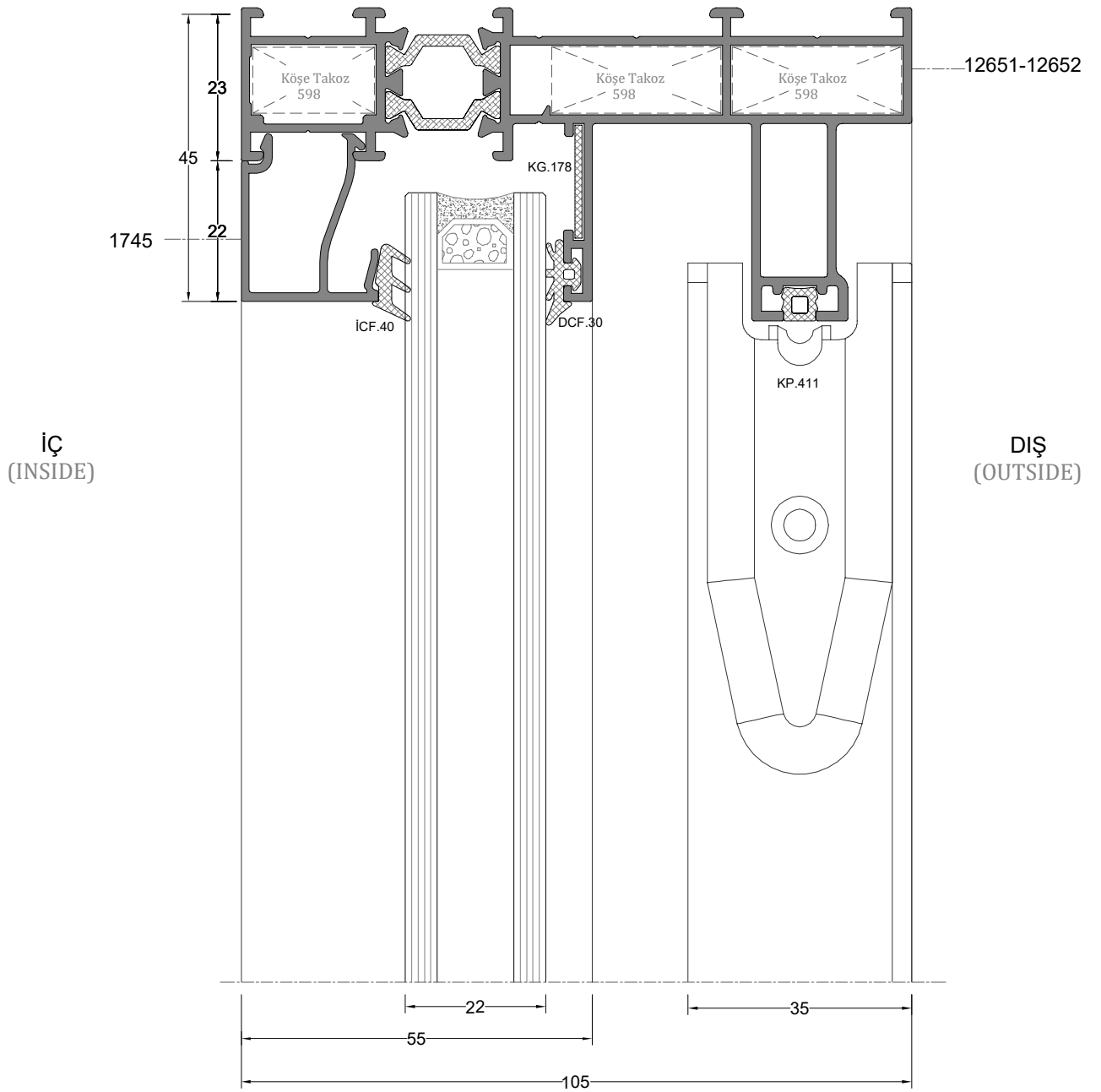
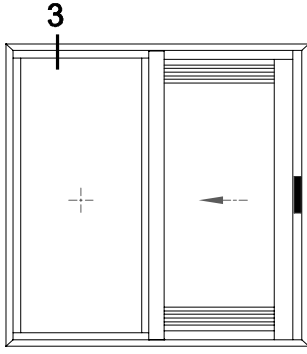

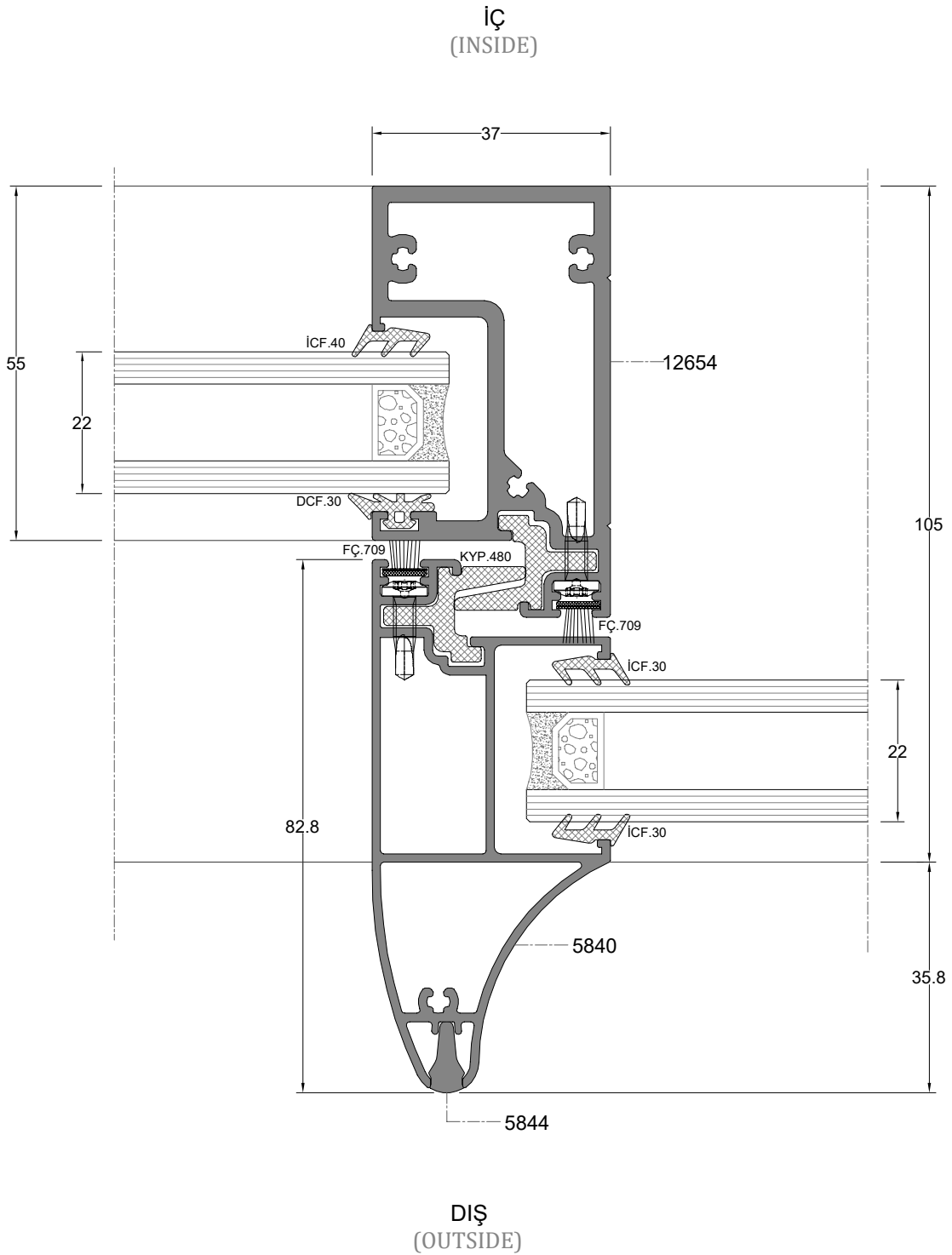
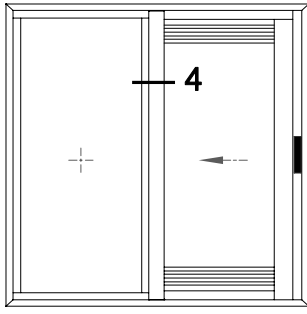

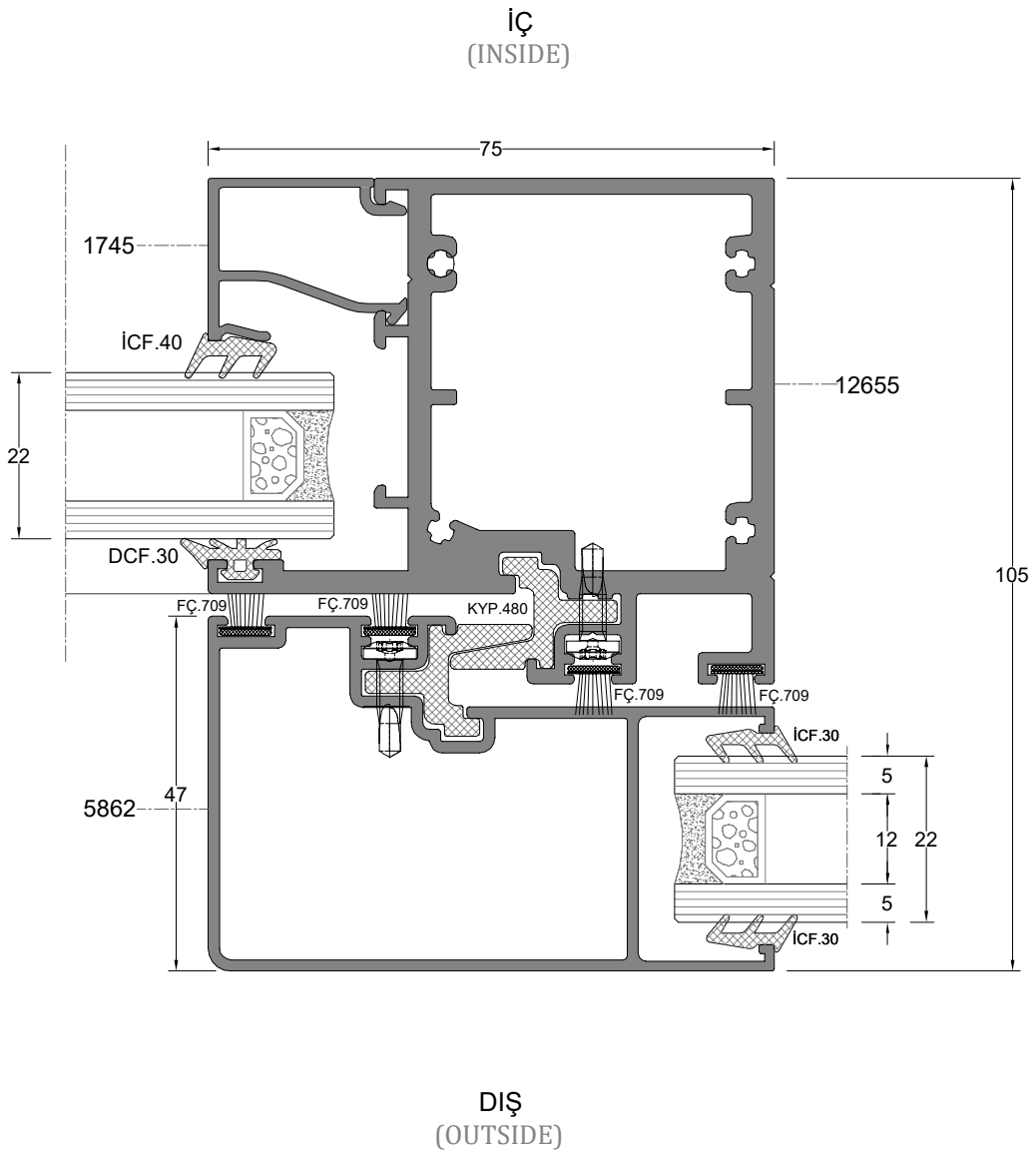
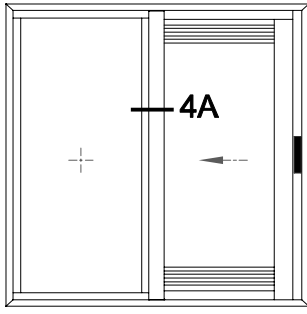

**WD55T Sistemindeki pvc ve euro kanallı içe açılır kanat profilleri kullanıma uygundur.

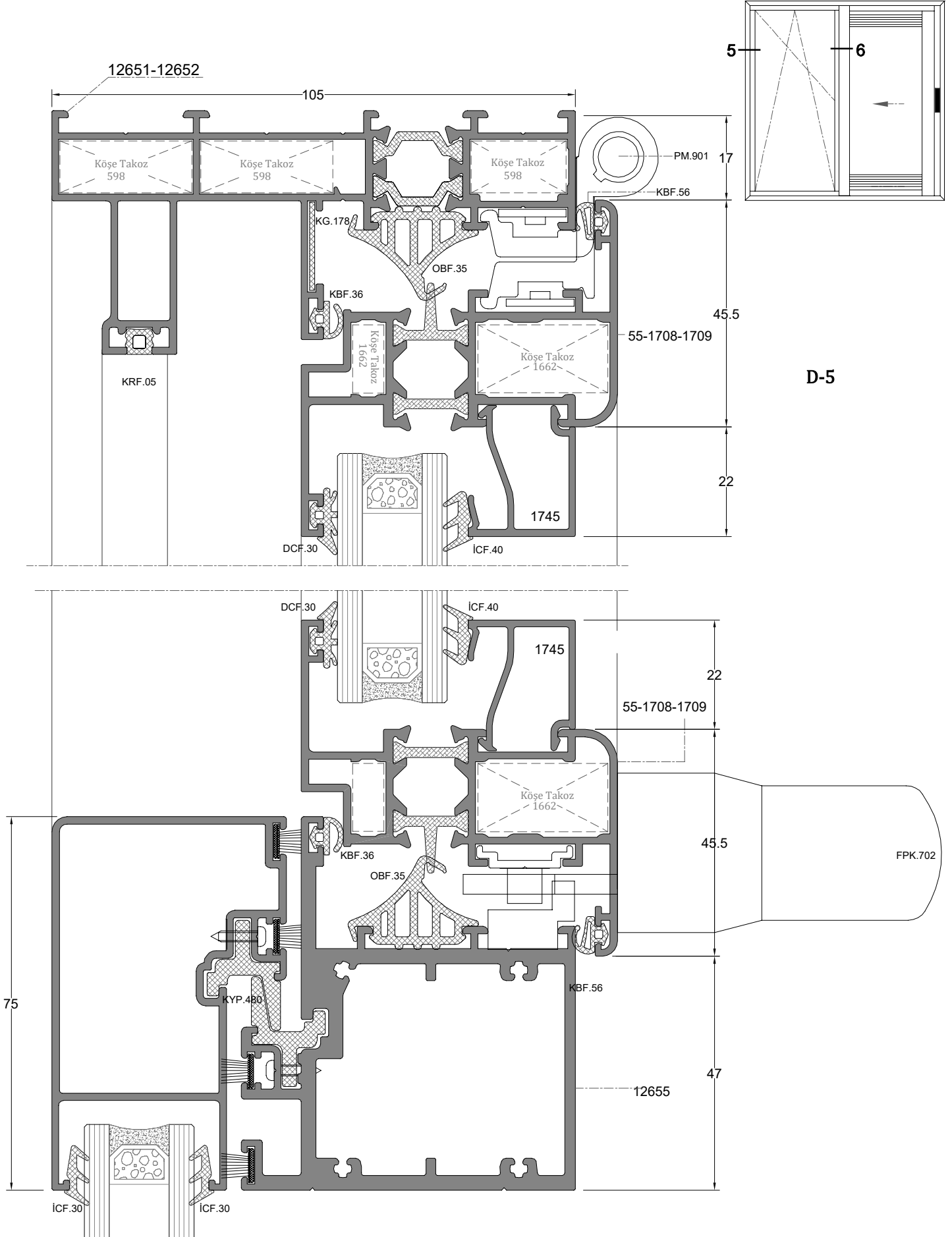

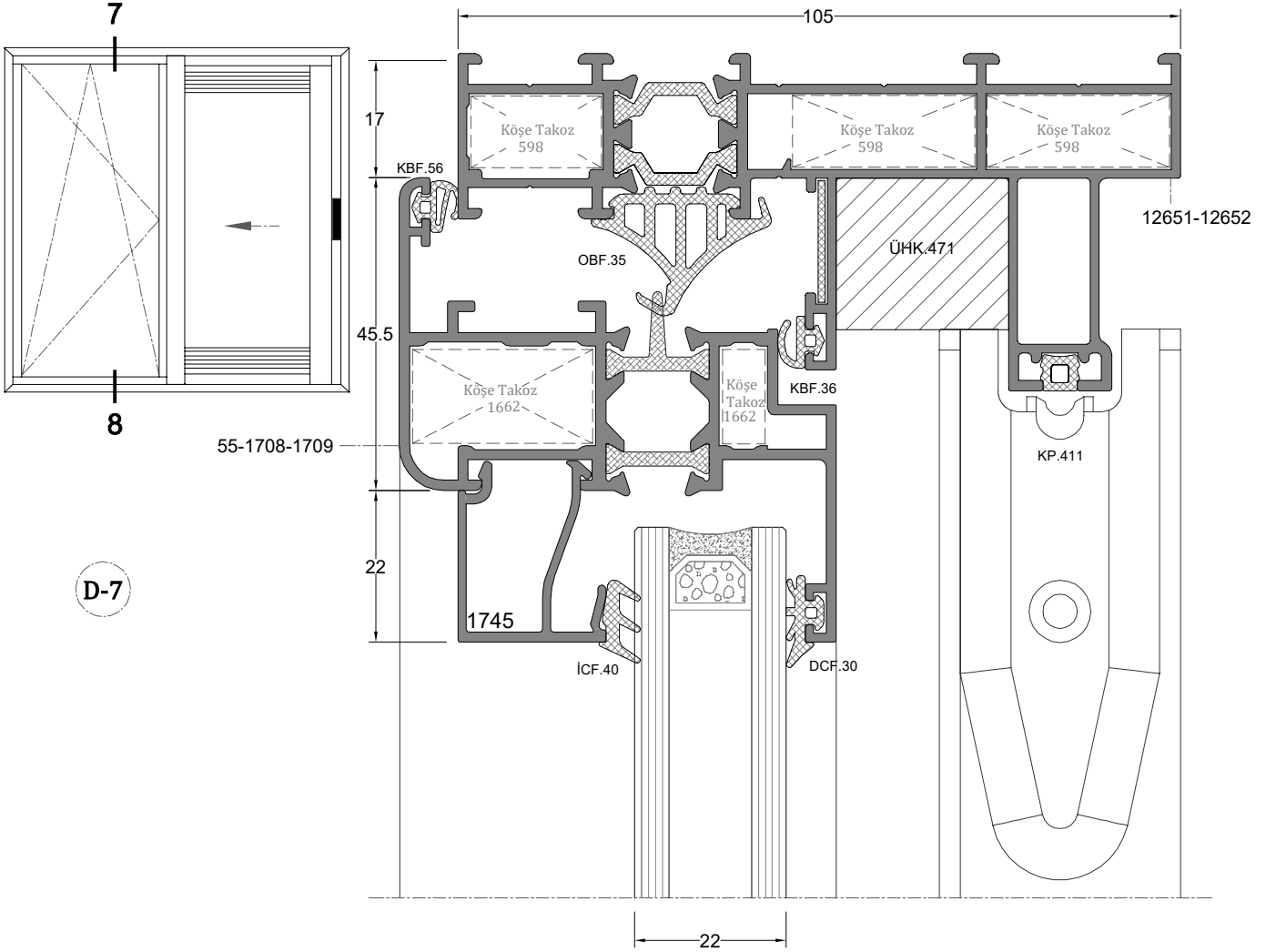

D-7

İÇ
(INSIDE)

DIŞ
(OUTSIDE)

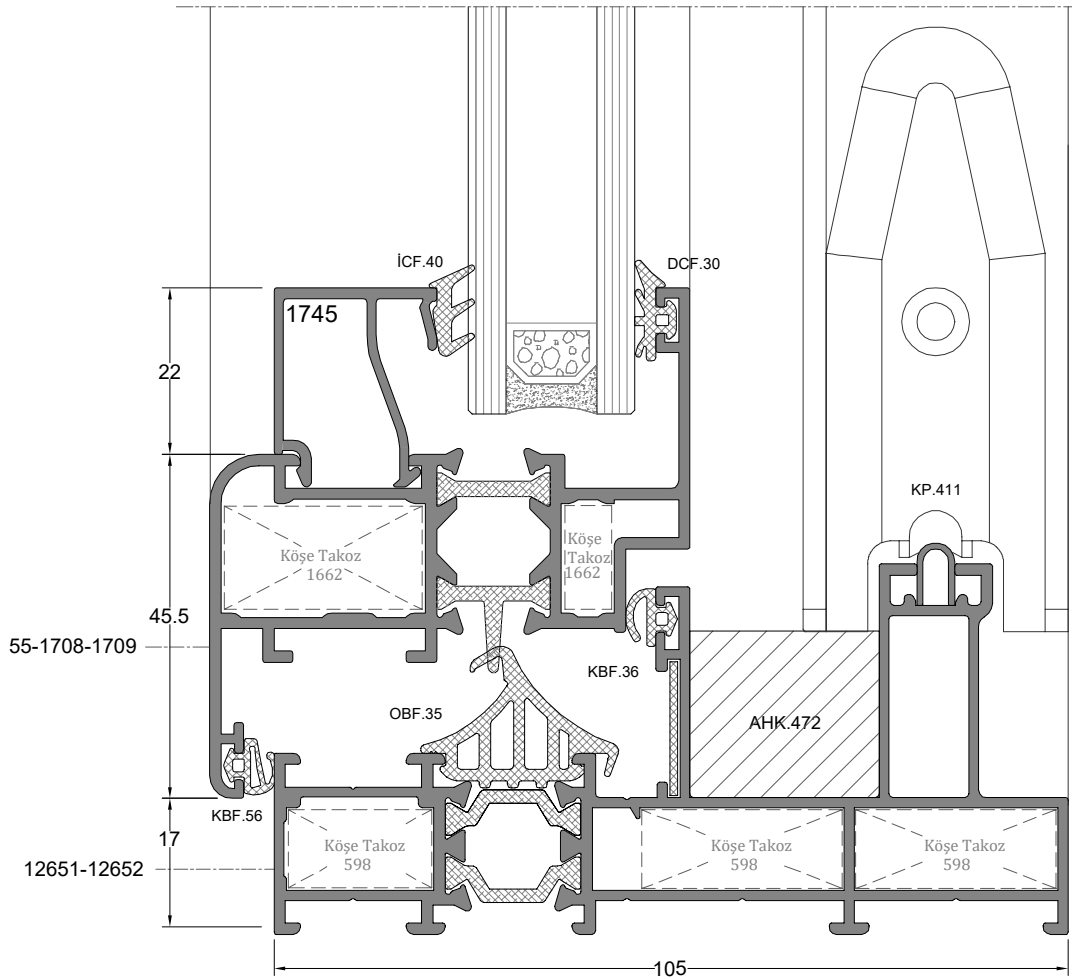

D-8

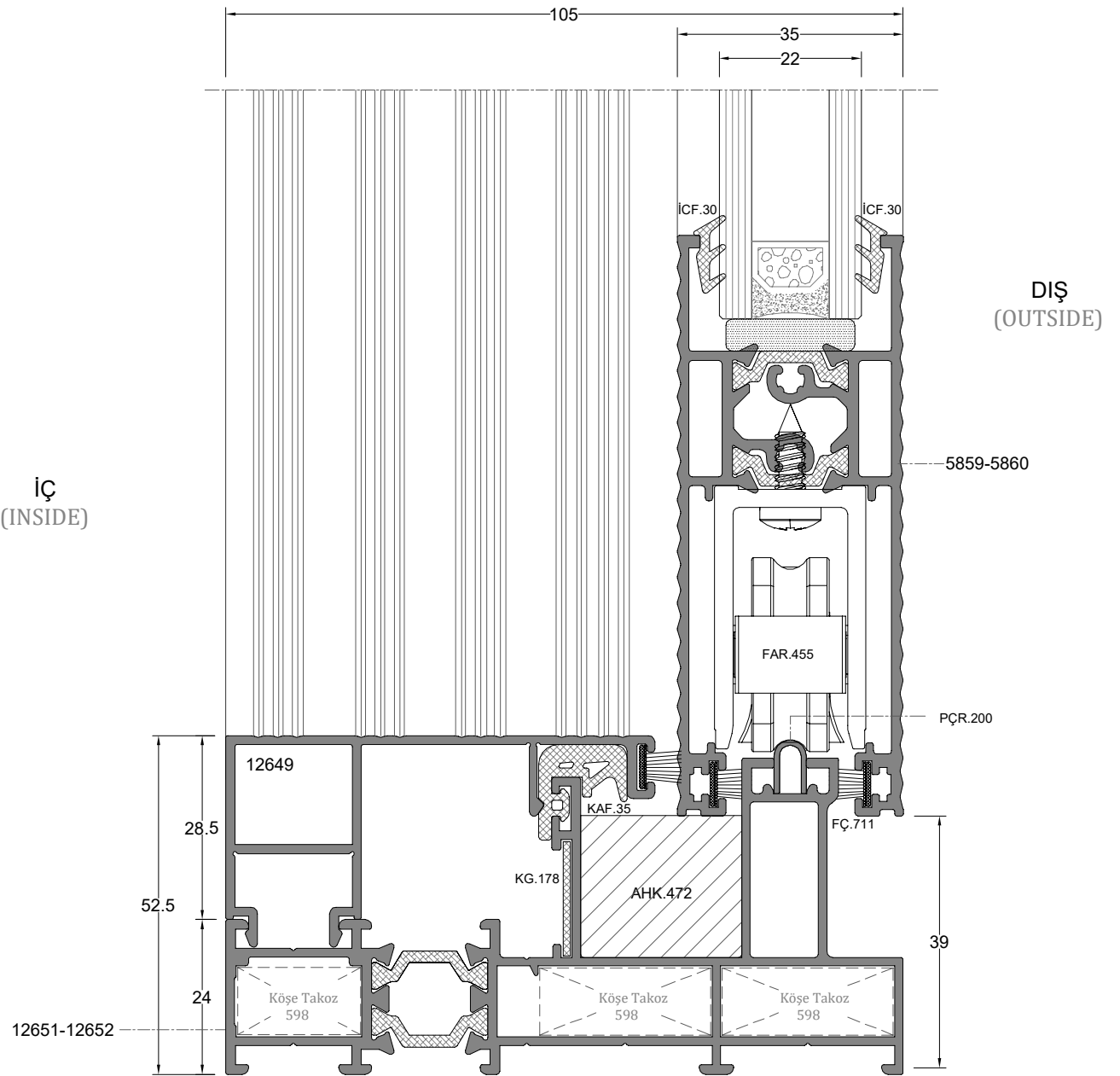
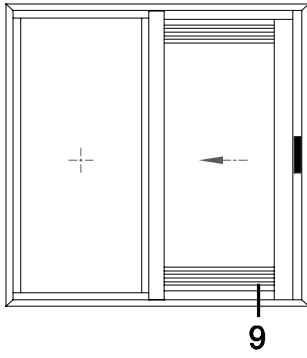

D-9

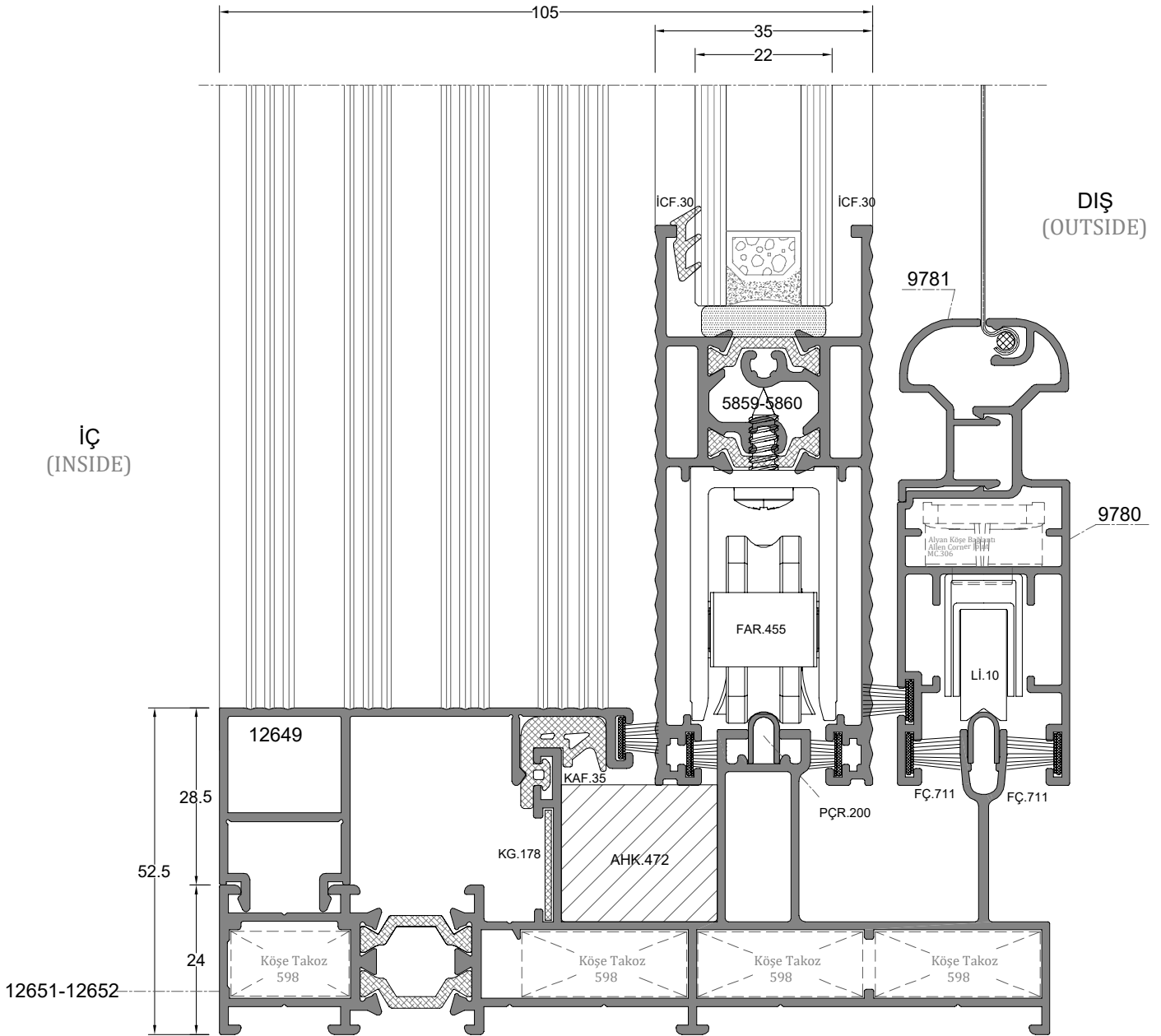
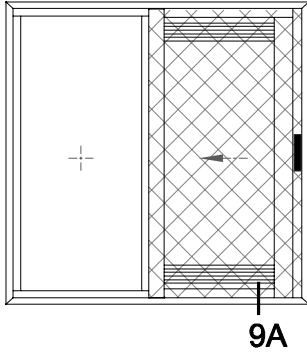

D-9A

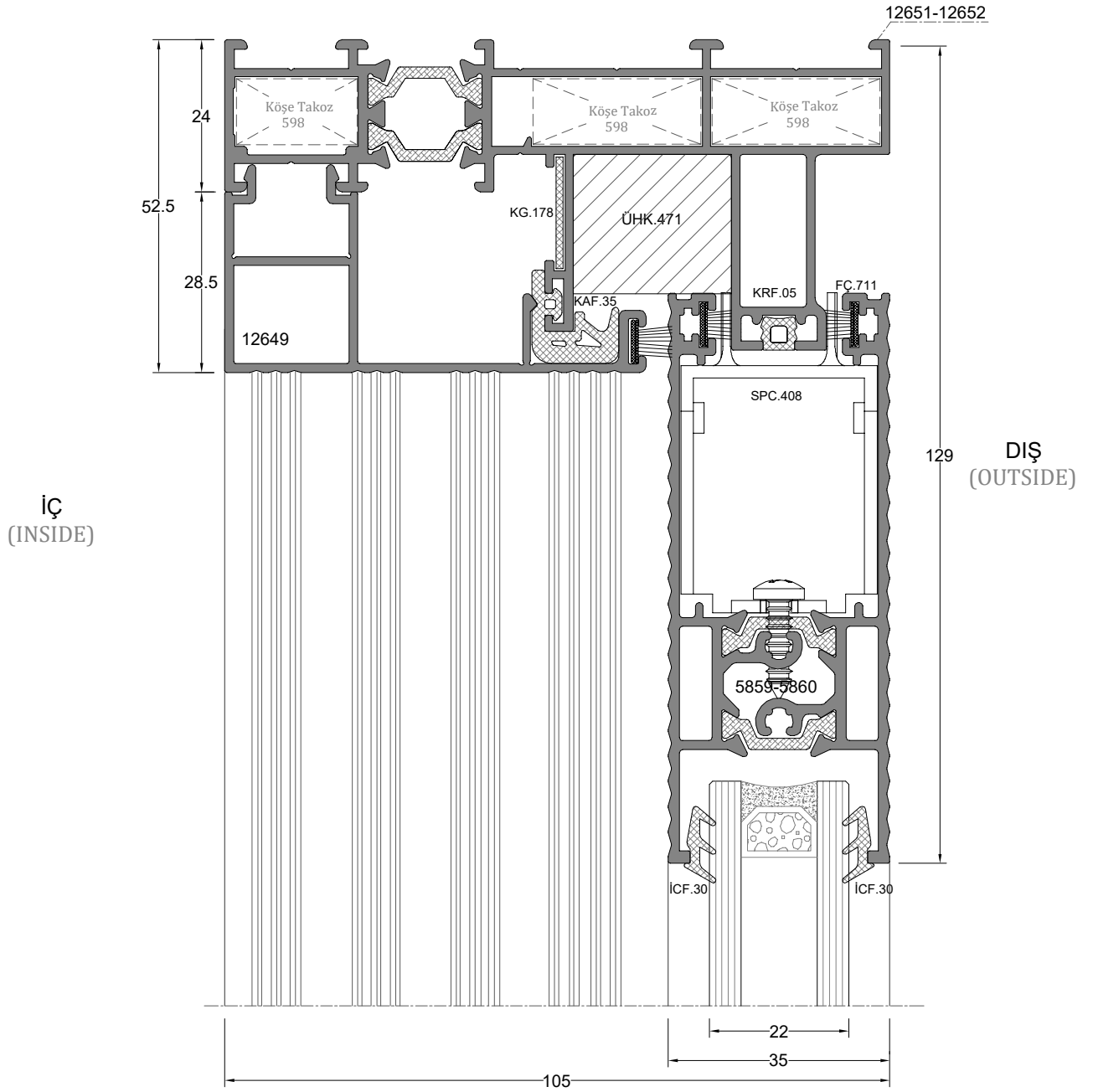
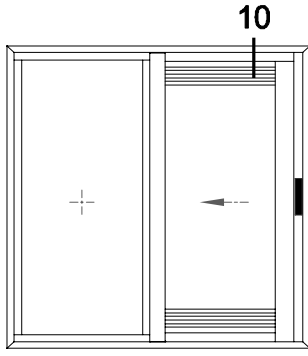

D-10

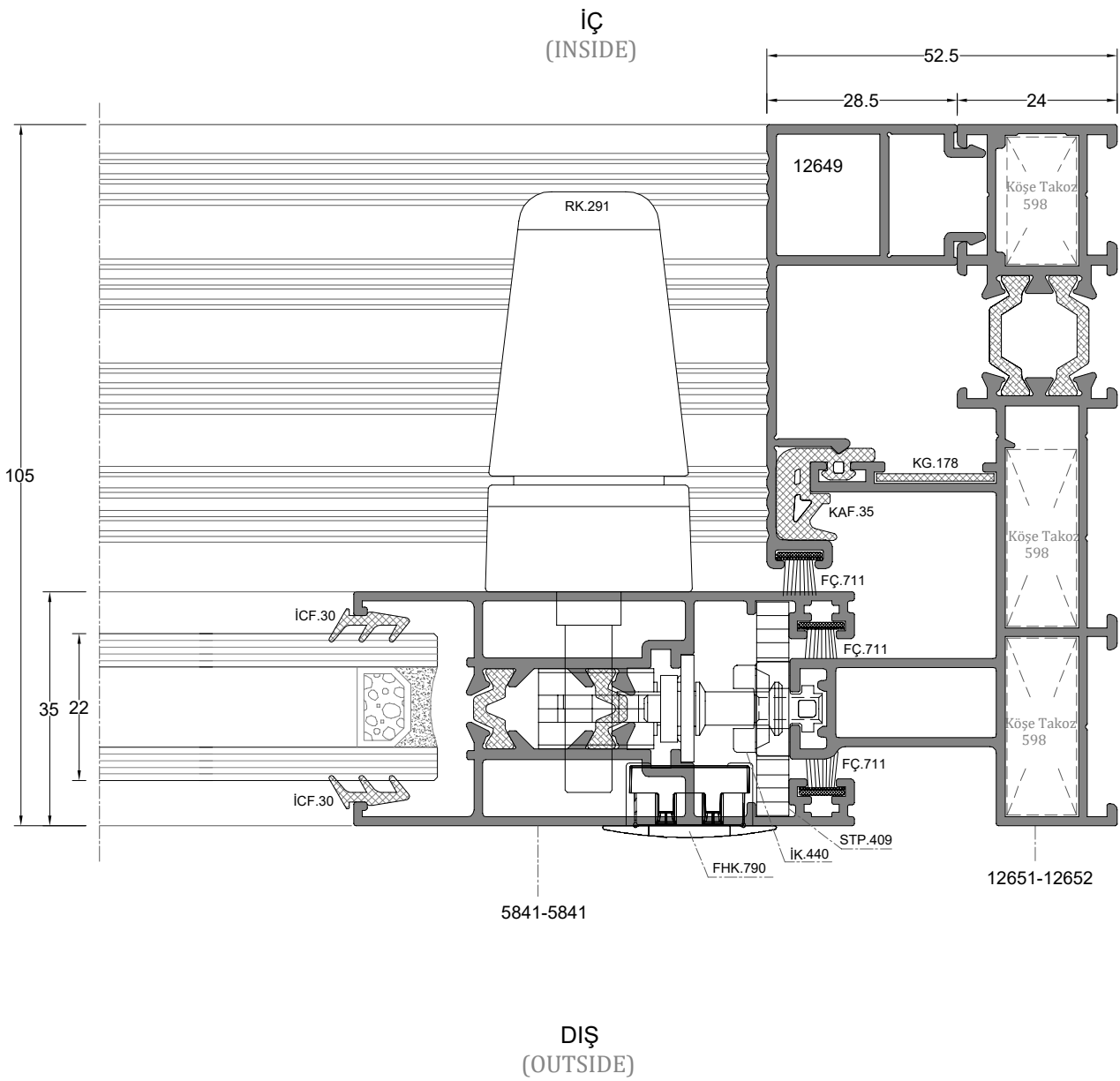
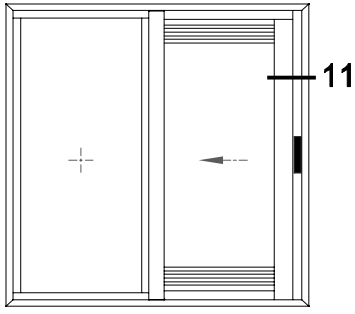

D-11

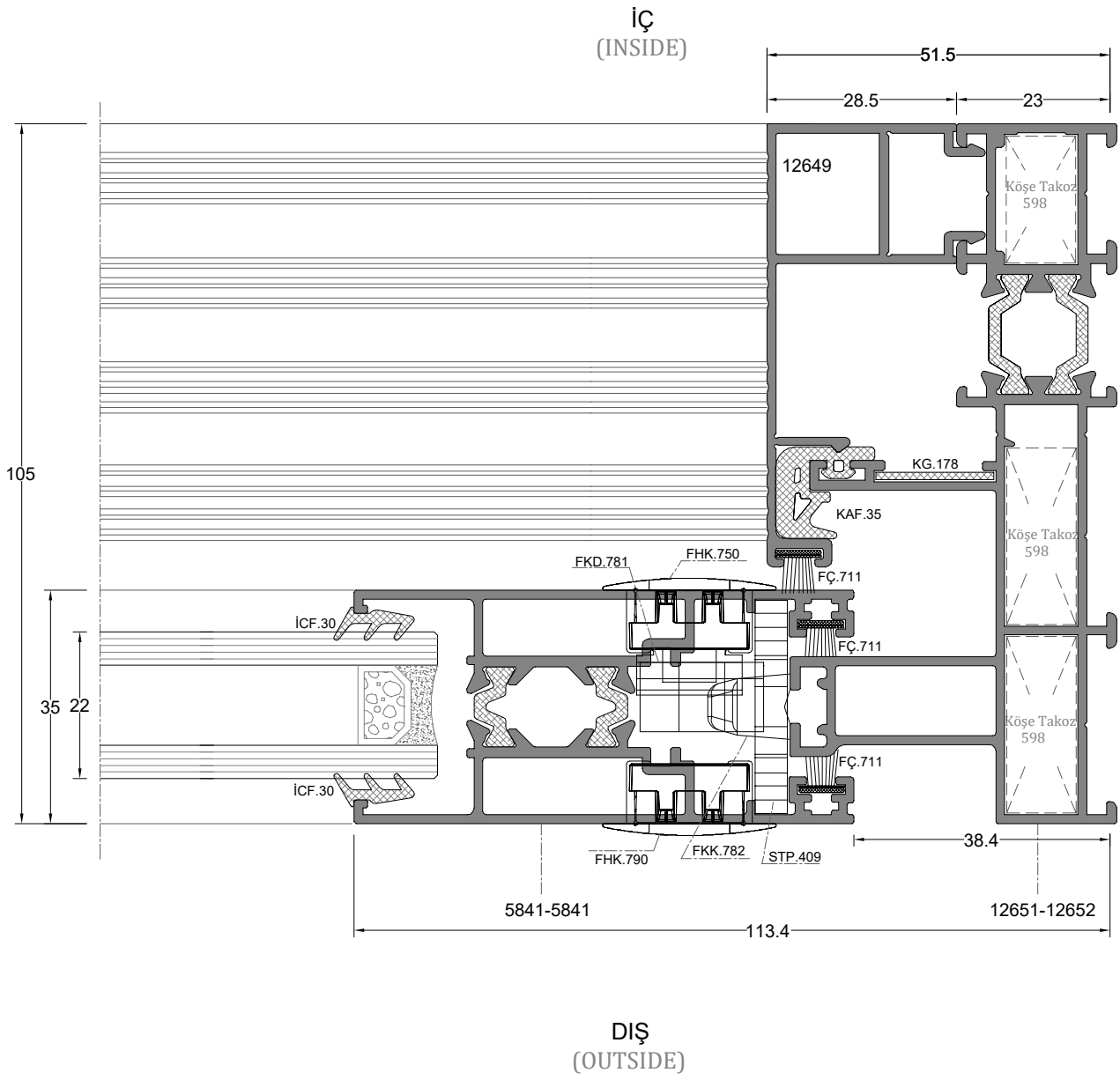
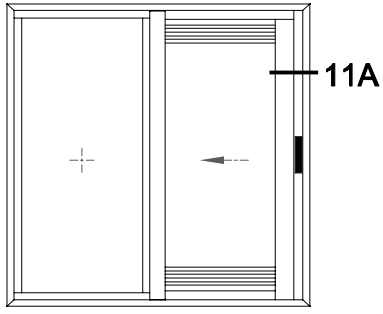

D-11A

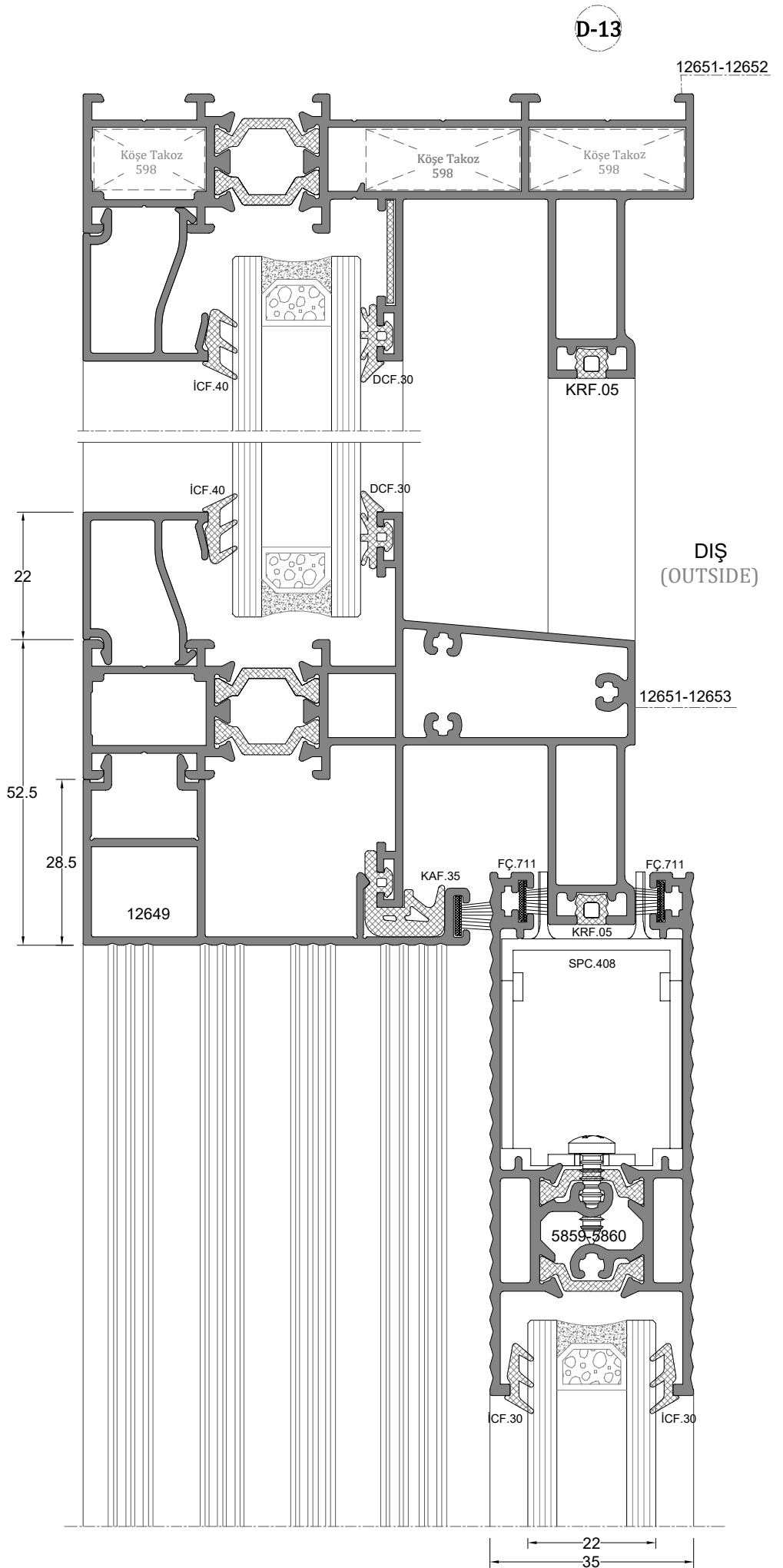
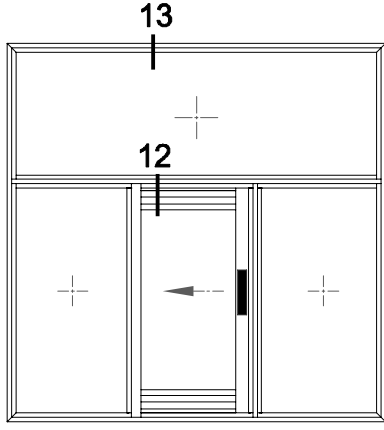

D-12

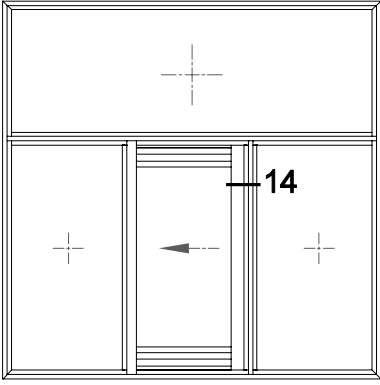

İÇ
(INSIDE)

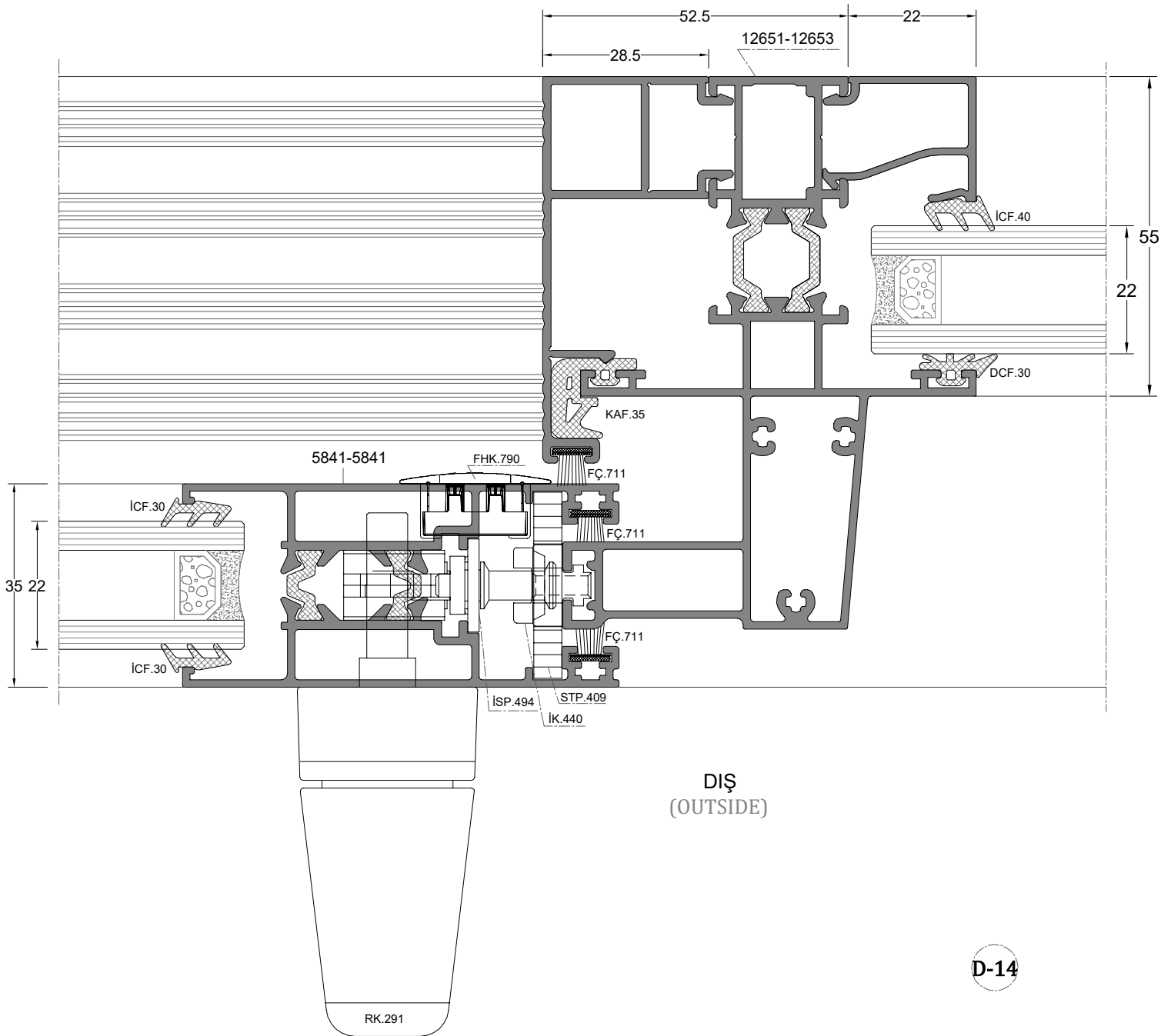

D-14

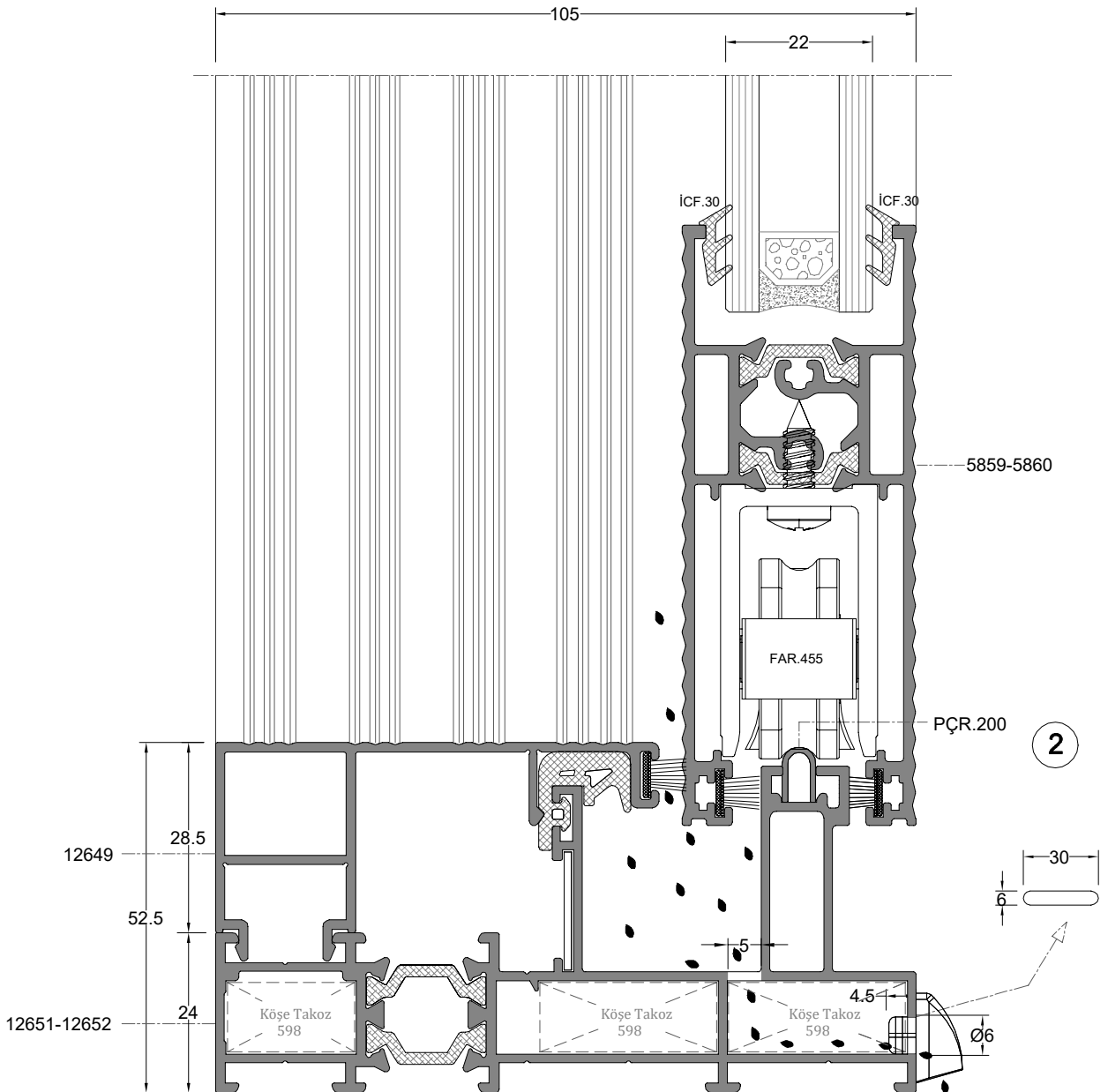
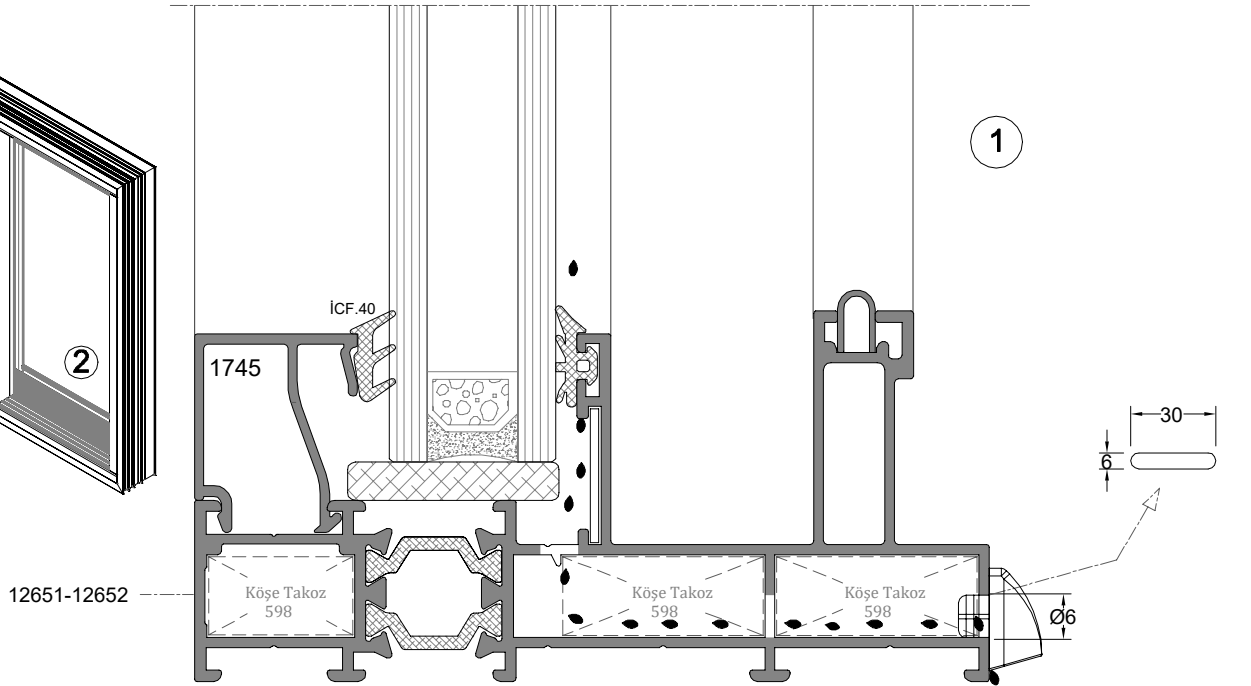
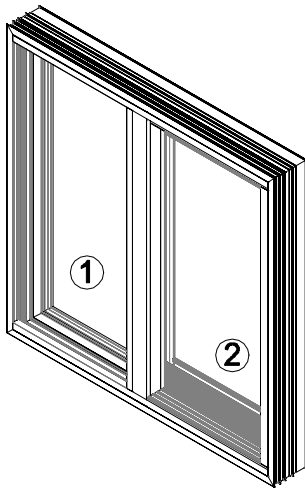

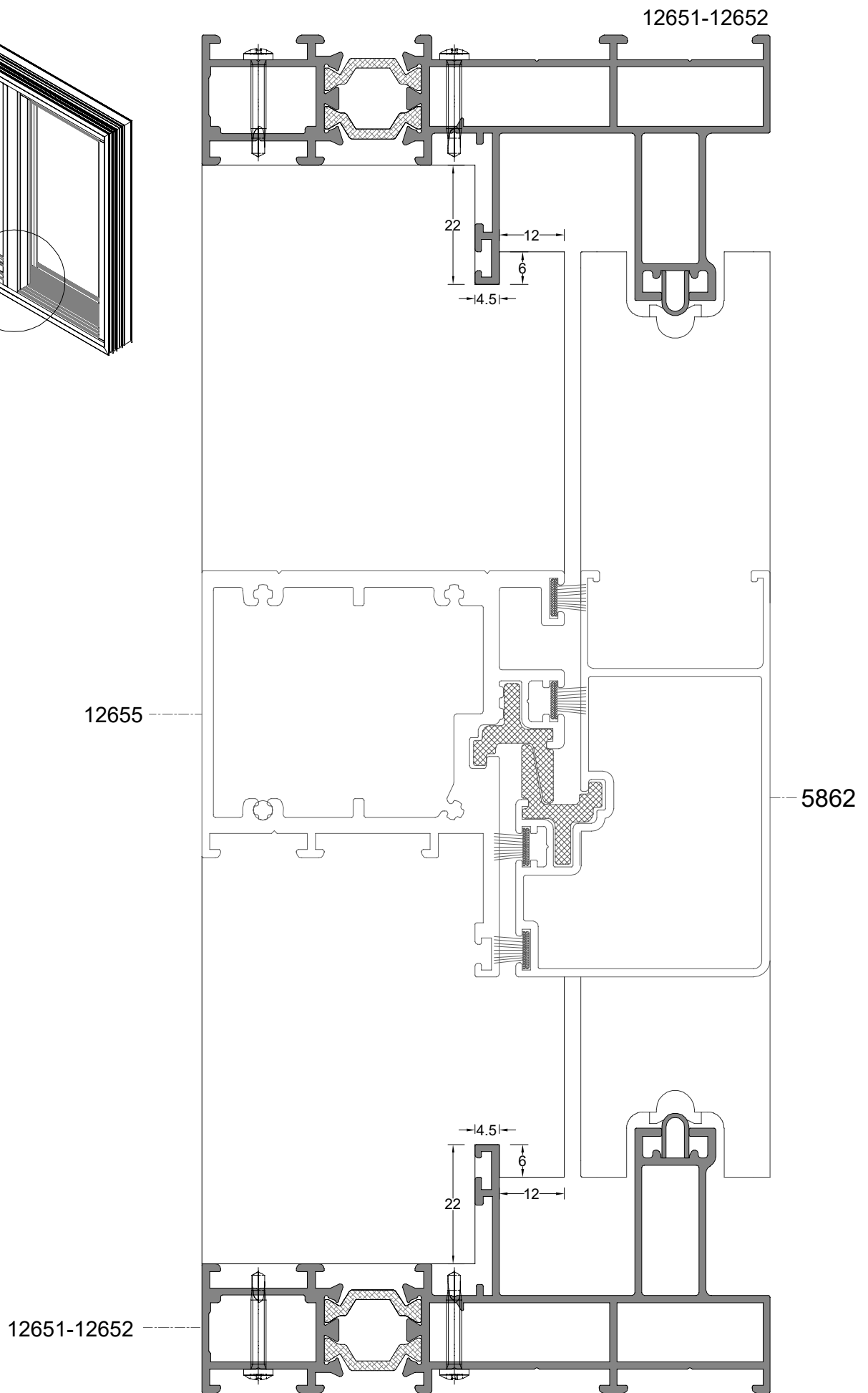
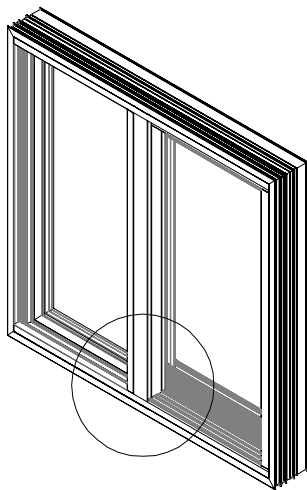

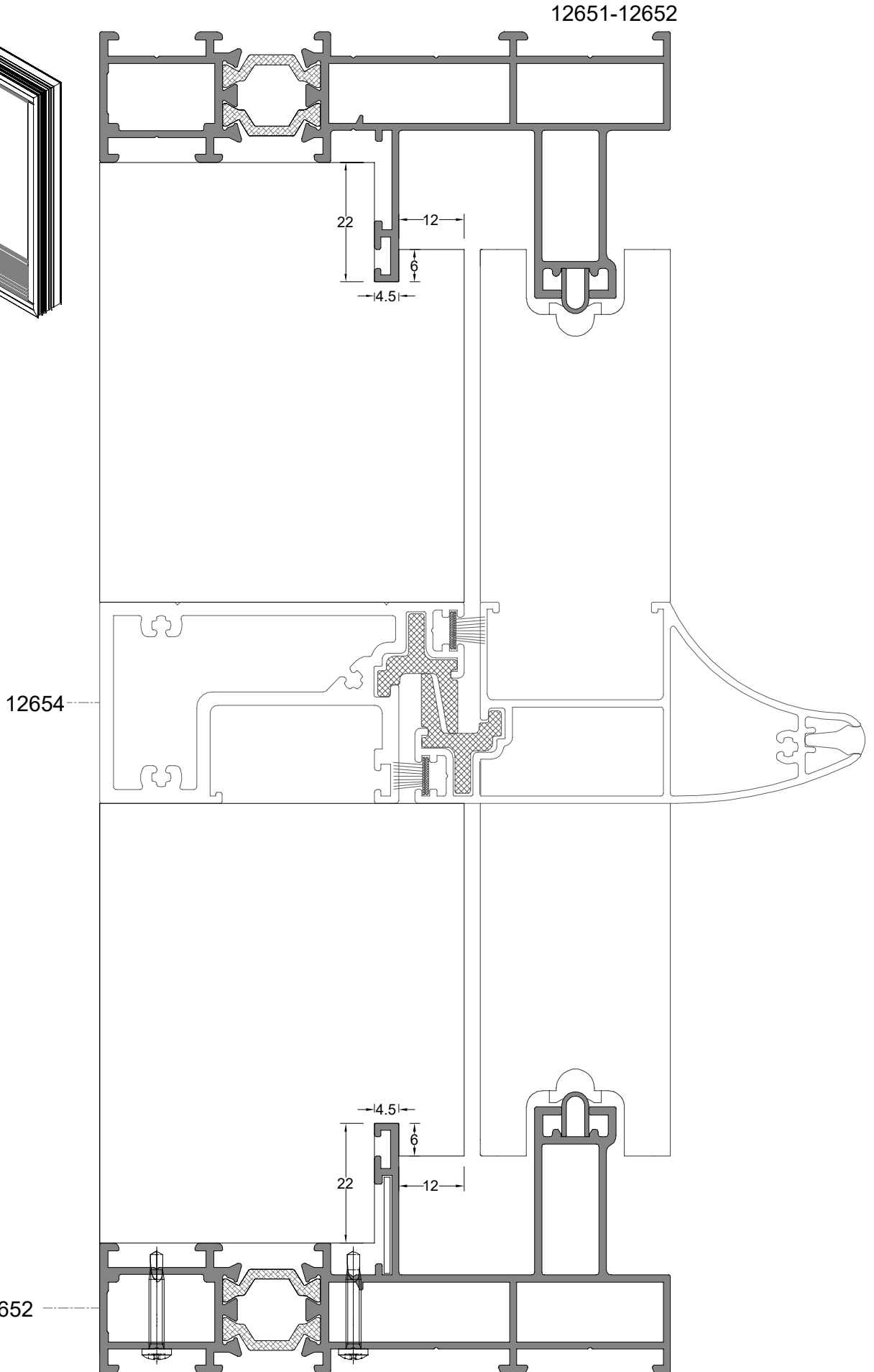
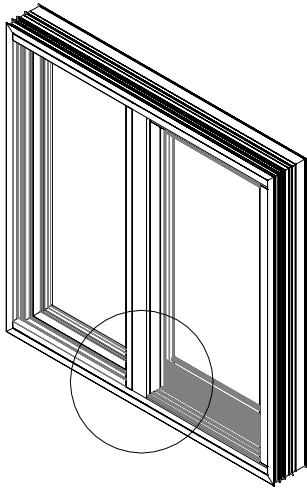

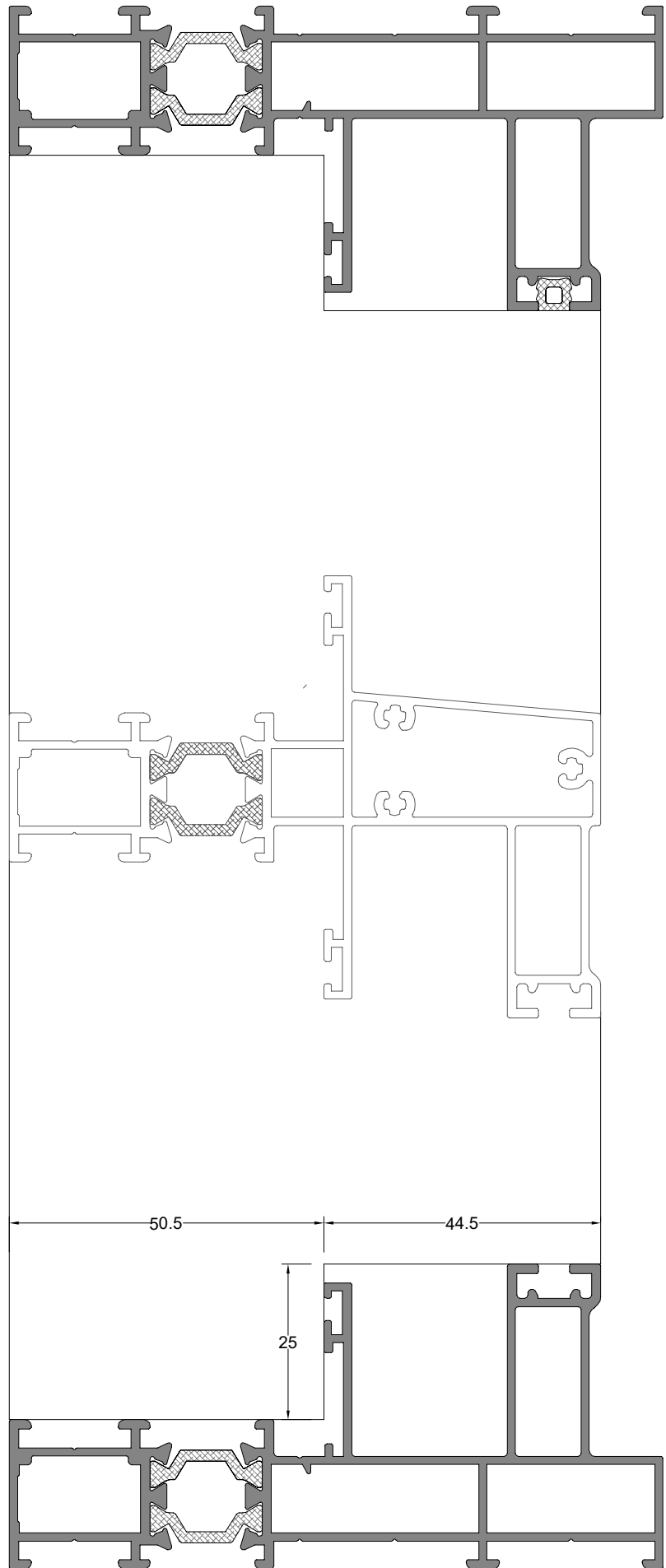
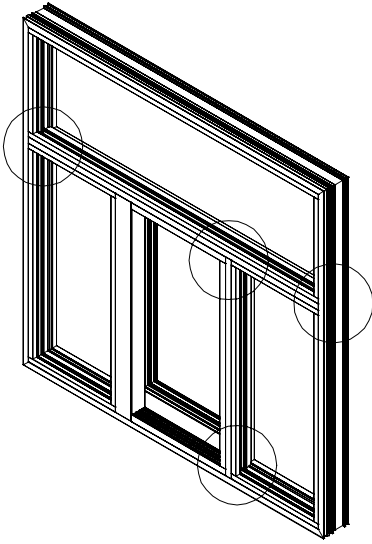

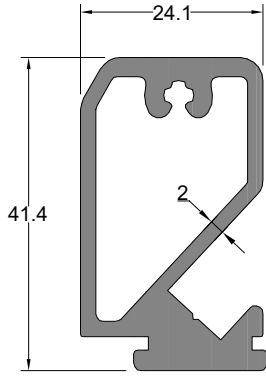

Orta Kayıt Bağlantı Profil MULLION CONNECTION PROFILE	Profil Kodu Profile Code	(kg/mt) Weight
	1773	0,985

Dik Bağlantı Kodu	Kullanıldığı Profil	Kesim ölçüsü	Adet Kesim Kodu
1773	12651	35,2 mm	OKB - 1773 - 35,2

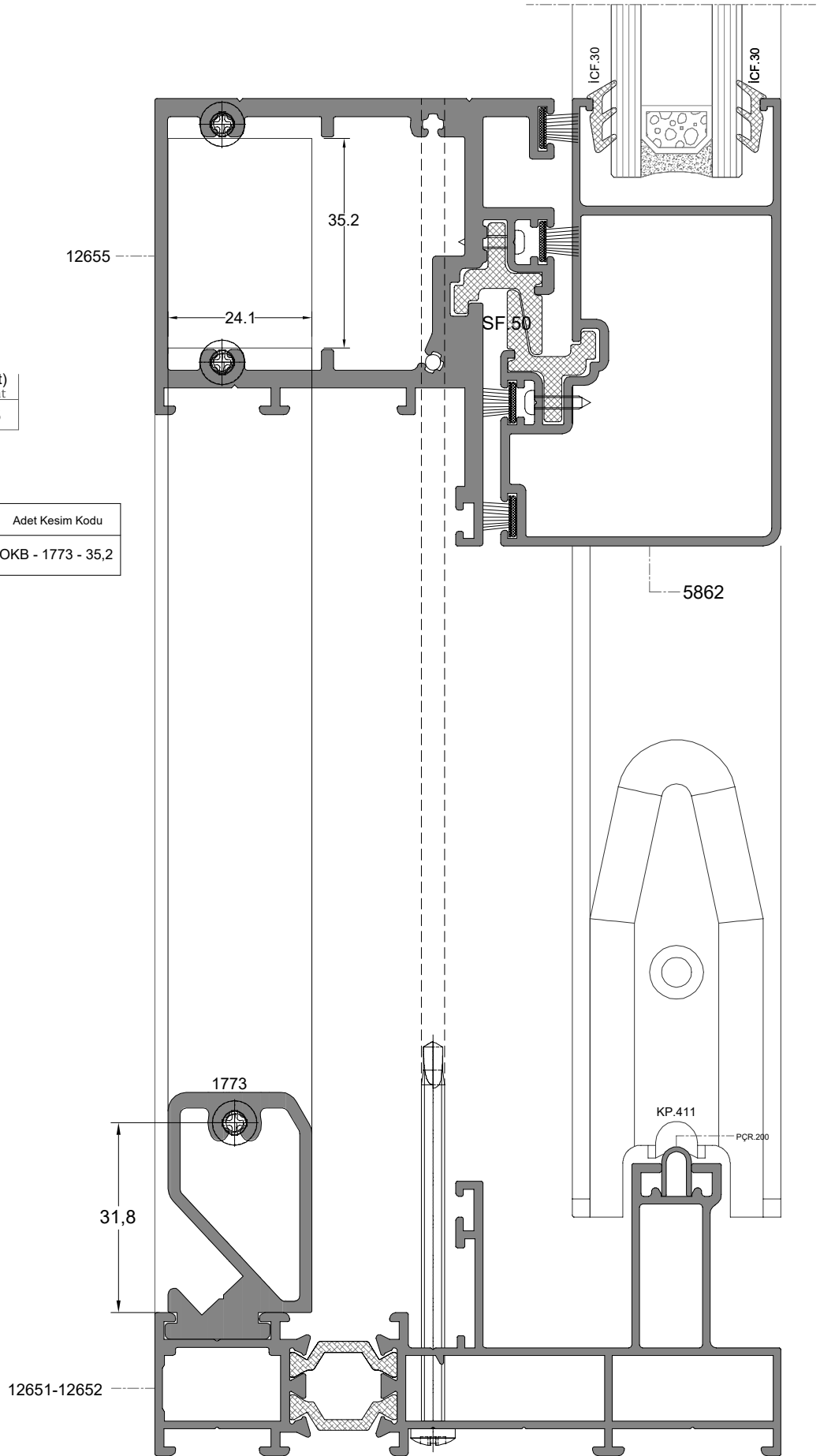

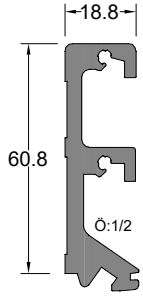
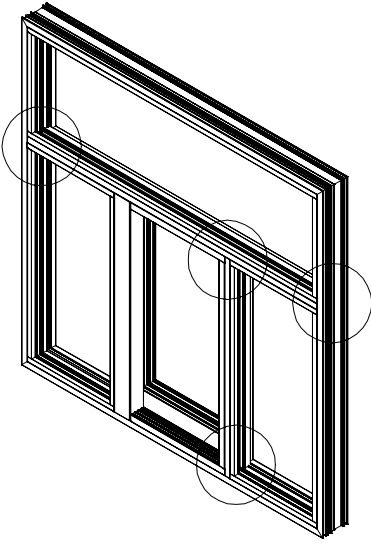

Orta Kayıt
Bağlantı Profili
MULLION CONNECTION
PROFILE

Profil Kodu Profile Code	(kg/mt) Weight
11626	1,502

Dik Bağlantı Kodu	Kullanıldığı Profil	Kesim ölçüsü	Adet Kesim Kodu
11626	12651	10,5 mm	OKB - 1773 - 10,5

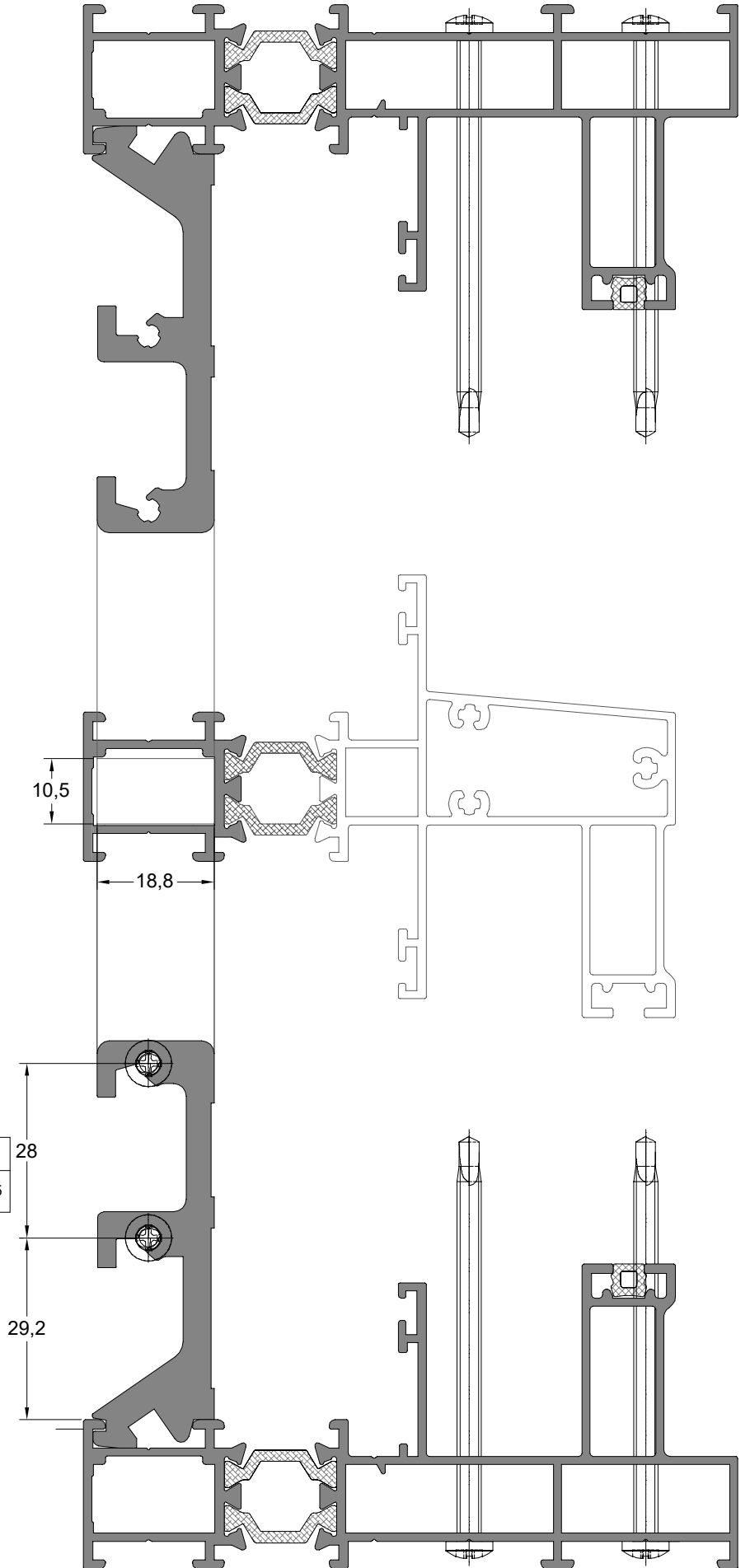

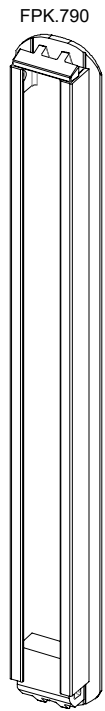
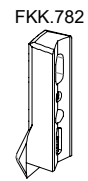
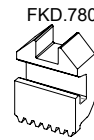
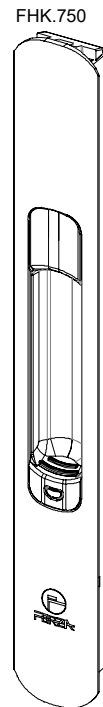
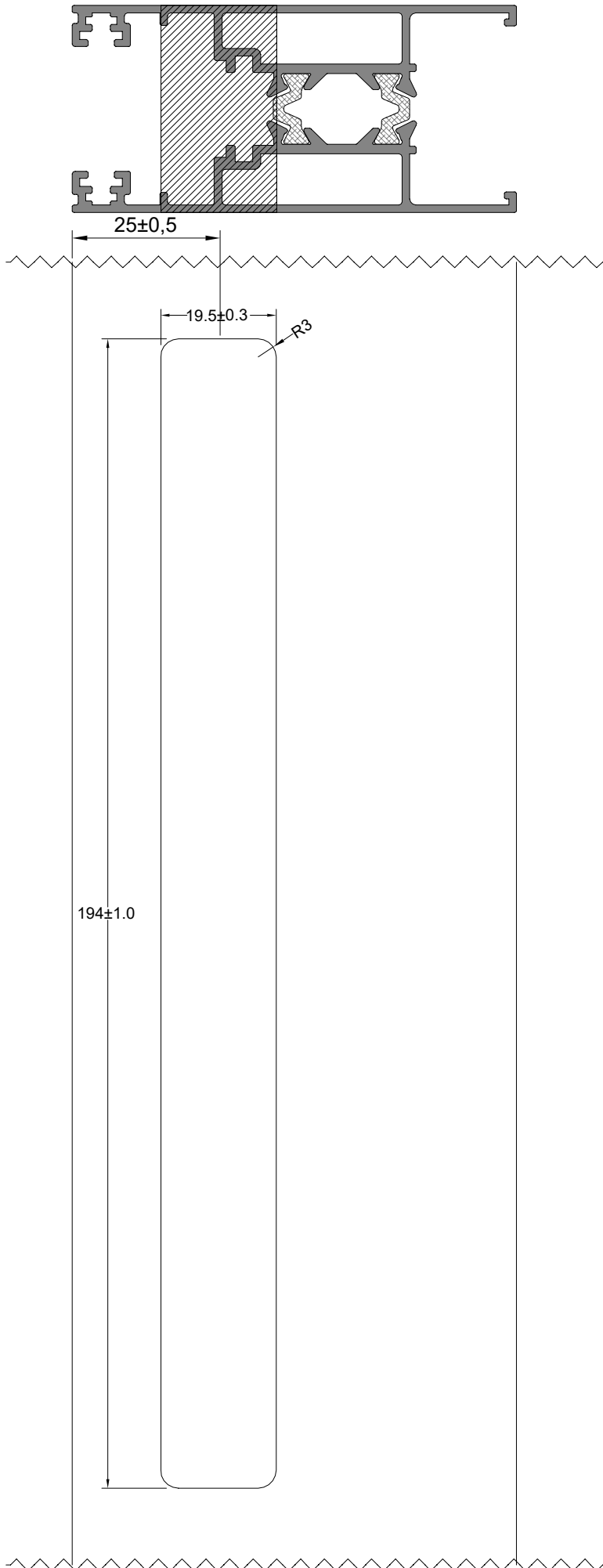

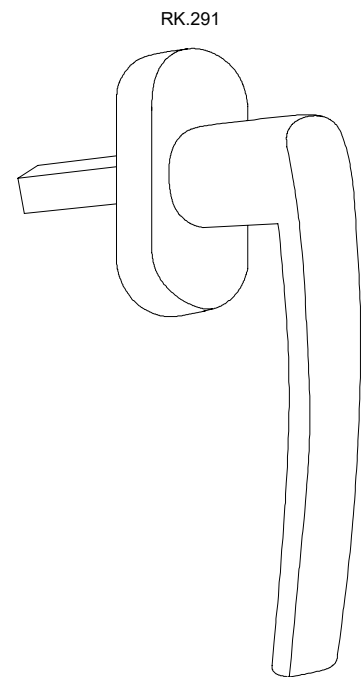
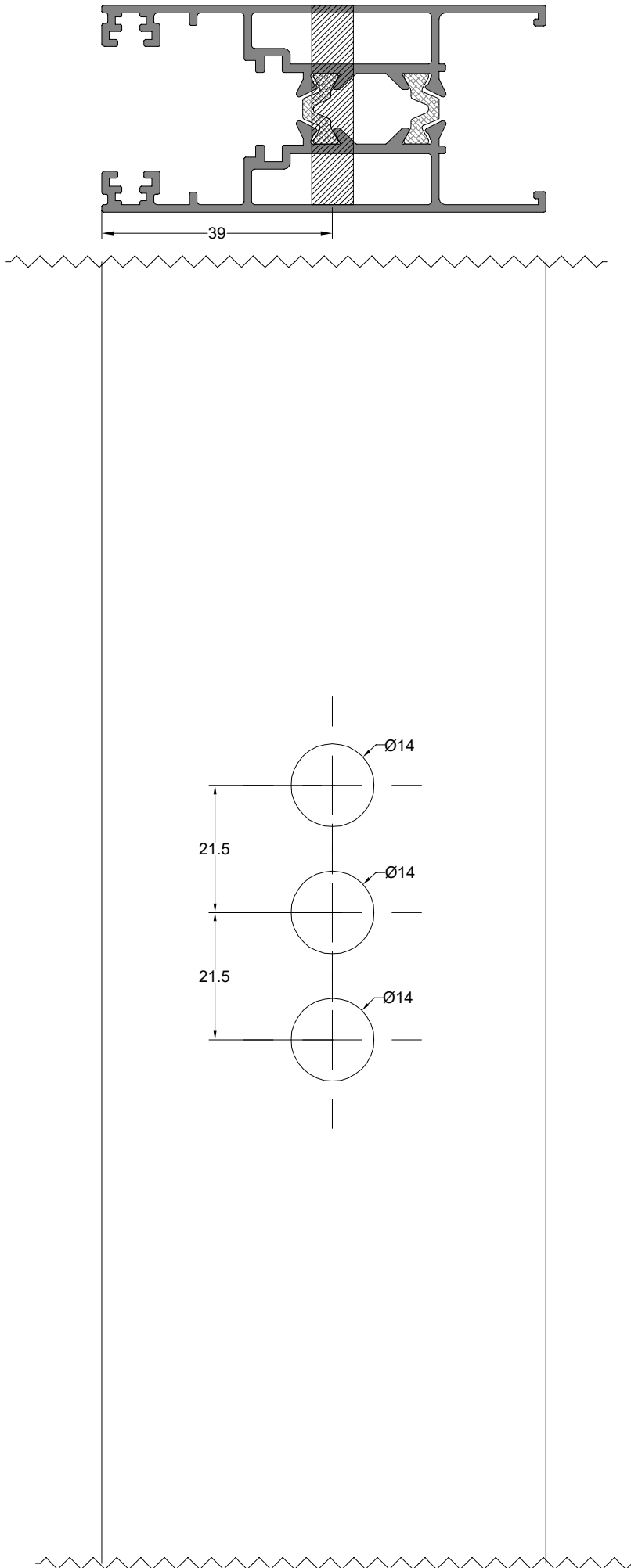

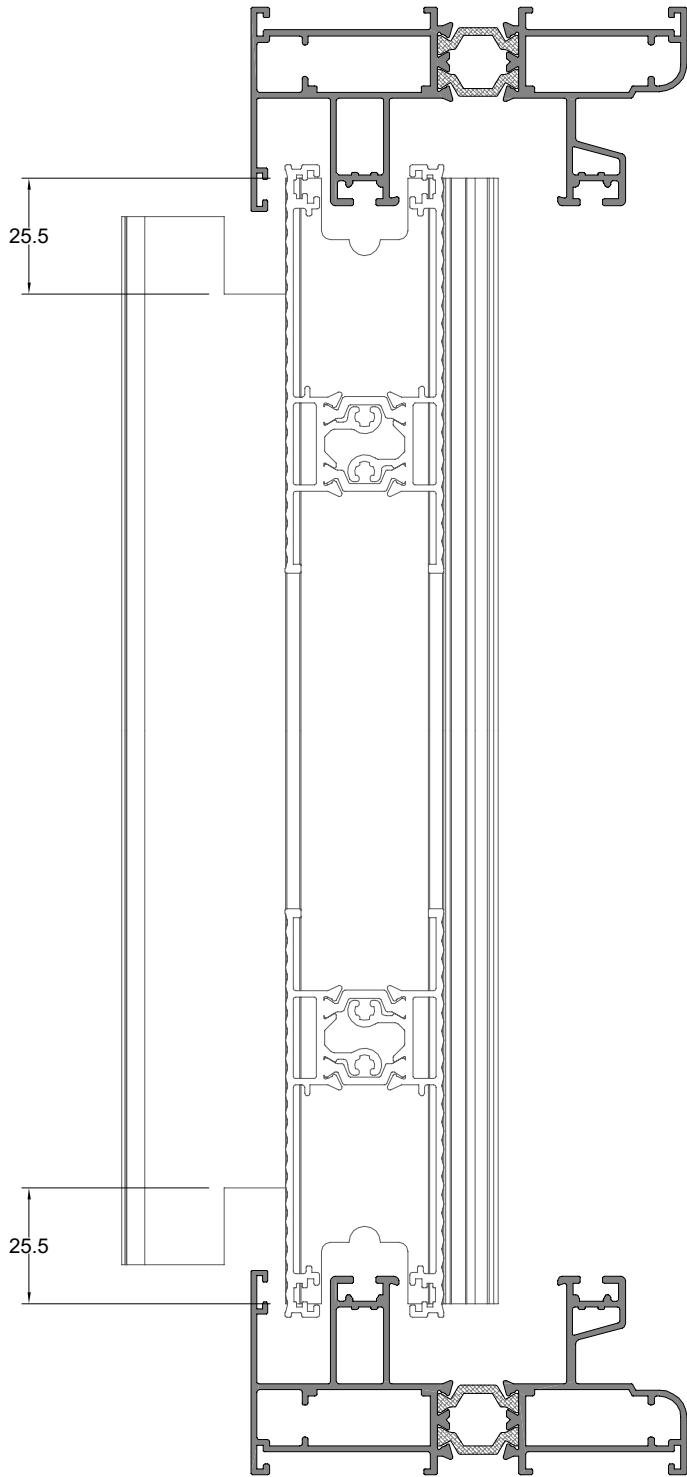

KB.905

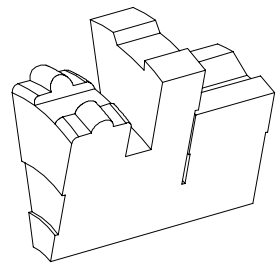

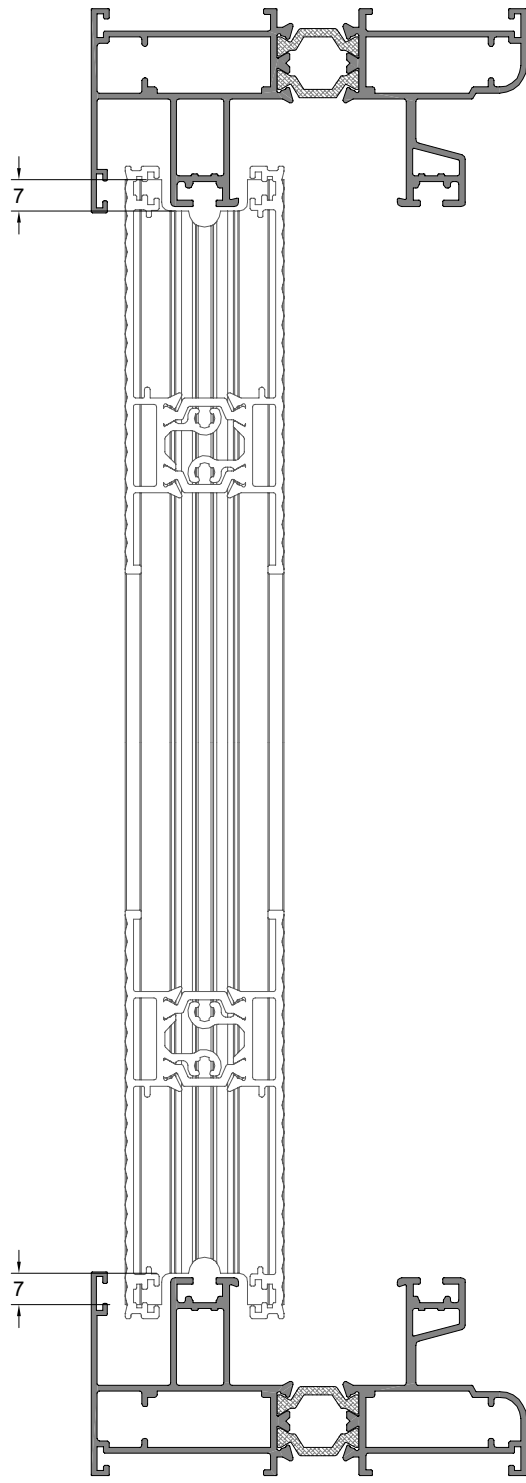

KB.905

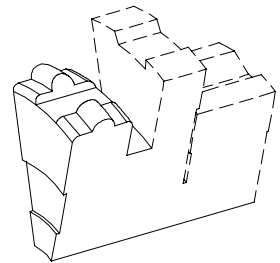

5841-5841



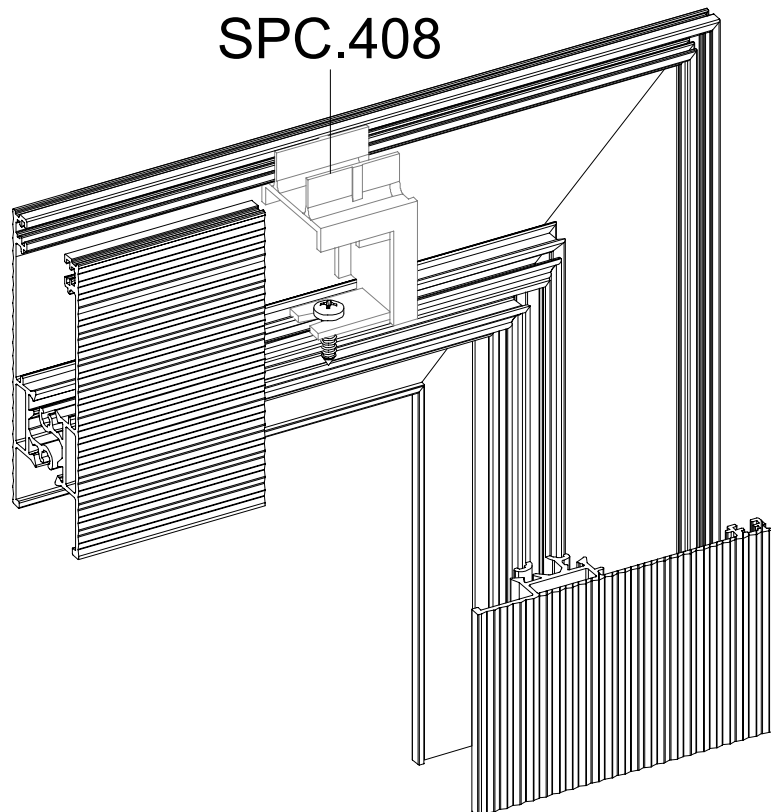
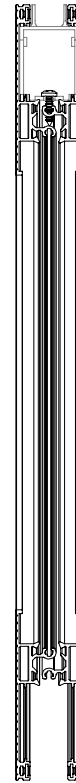
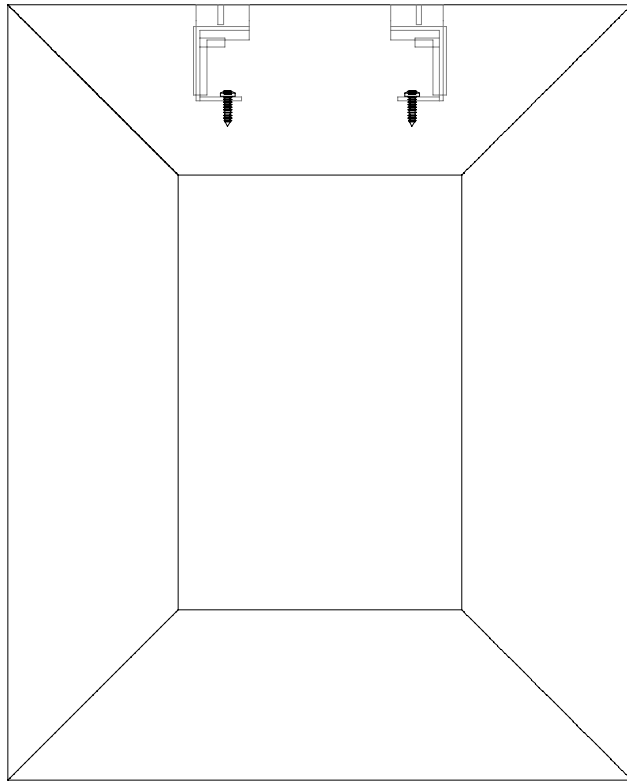

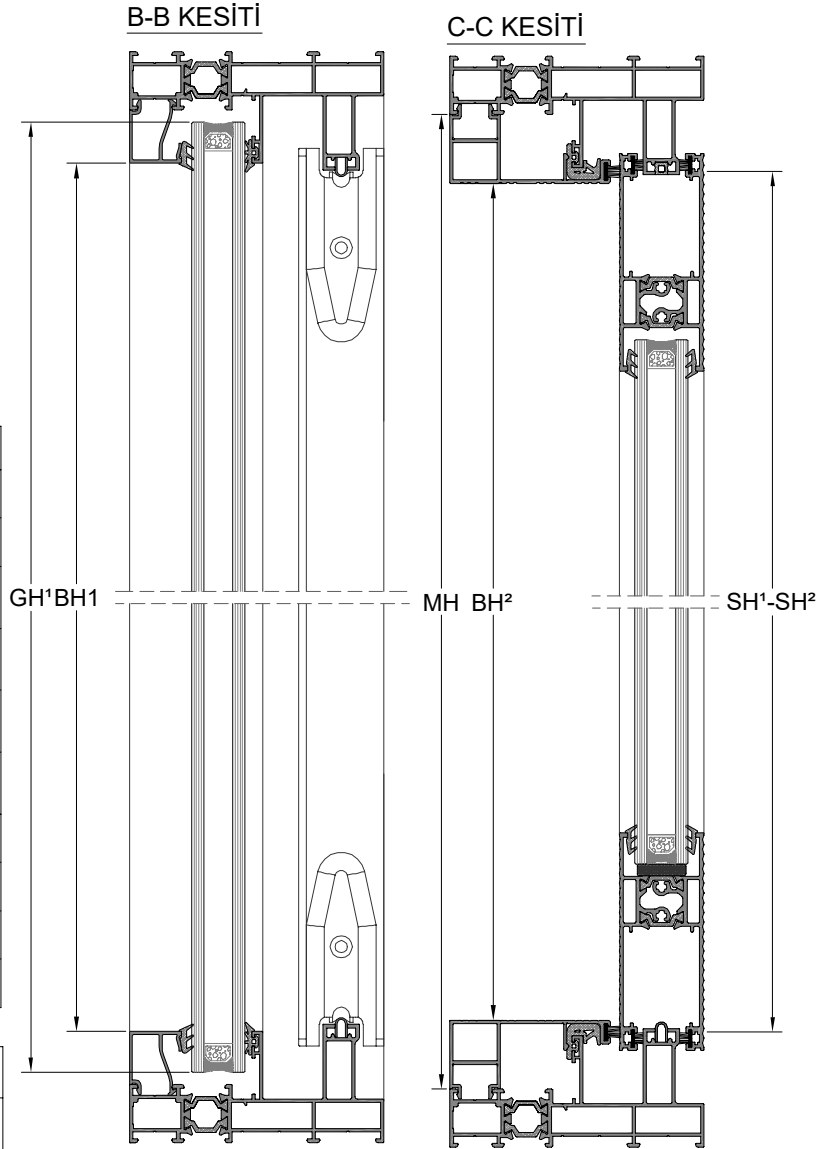
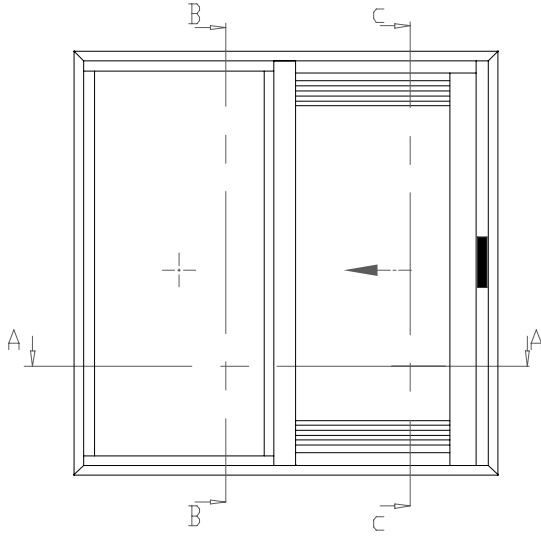

PROFİLLER / PROFILES

Kod Code	Çizim Drawing	Kesim Cut	Miktar Quantity	Ölçüler Dimensions
12651-12652 Kasa Frame			2 Pcs / Adet	FL
			2 Pcs / Adet	FH
5841-5841 Kanat Sash			1Pcs / Adet	SH¹= FH-86
5862 Kanat Sash			1Pcs / Adet	SH²= FH-86
5859-5860 Kanat Sash			2Pcs / Adet	SL= (FL/2)-119
12655 Kenet Sash			1Pcs / Adet	MH = FH-48 ML=(FL/2)-39
1745 Çita Bead			2Pcs / Adet	BL¹ = (FL/2)-78
			2Pcs / Adet	BH¹ = FH - 92
12649 Çita Bead			2Pcs / Adet	BL² = (FL/2)-23
			1Pcs / Adet	BH² = FH-105

CAM / GLASS

Kod Code	Çizim Drawing	Miktar Quantity	Ölçüler Dimensions
CAM GLASS		1 Pcs / Adet	GL¹ = (FL/2)-88
			GH¹ = FH-58
CAM GLASS		1 Pcs / Adet	GL² = (FL/2)-88
			GH² = FH-234

CAM ÖLÇÜLERİ EŞİT KABUL EDİLEREK FORMULİZE EDİLMİŞTİR.

GLASS DIMENSIONS ARE FORMULATED, ACCEPT EQUAL.

A-A KESİTİ

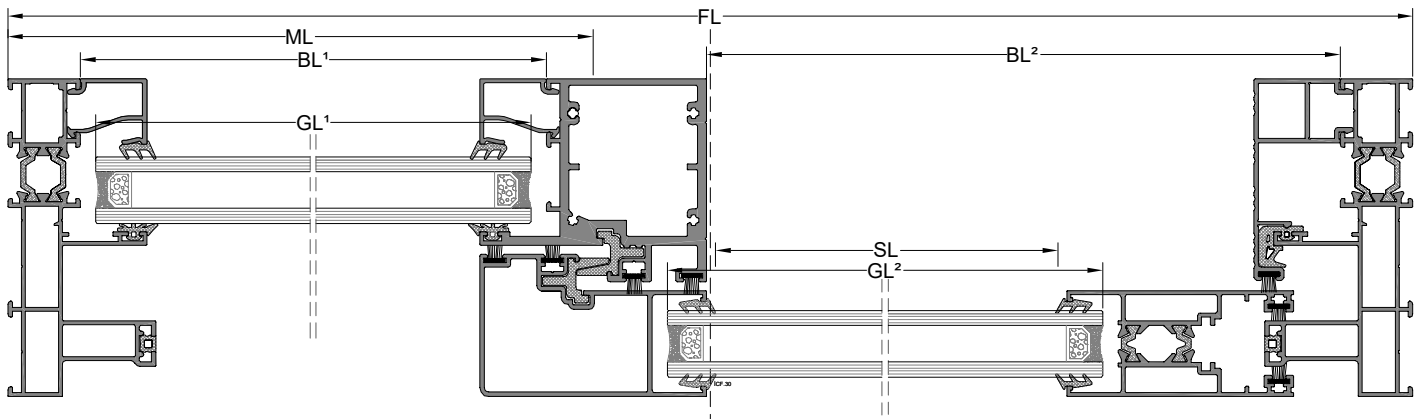

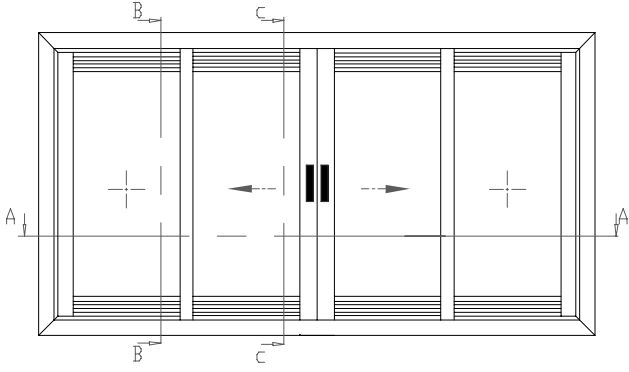

B-B KESİTİ

C-C KESİTİ

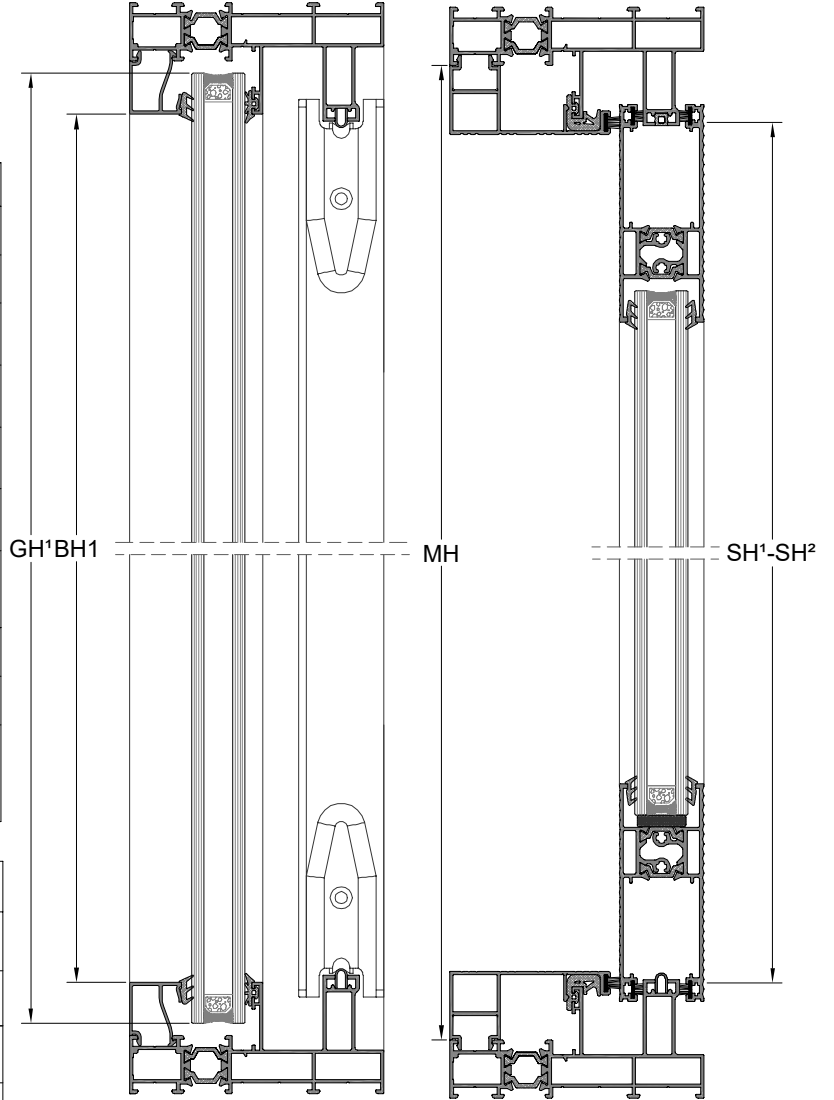

PROFİLLER / PROFILES

Kod Code	Çizim Drawing	Kesim Cut	Miktar Quantity	Ölçüler Dimensions
12651-12652 Kasa Frame			2 Pcs / Adet	FL
			2 Pcs / Adet	FH
5841-5841 Kanat Sash			2Pcs / Adet	SH¹= FH-86
5862 Kanat Sash			2Pcs / Adet	SH²= FH-86
5859-5860 Kanat Sash			4Pcs / Adet	SL¹= (FL/4)-101
12655 Kenet Sash			2Pcs / Adet	MH = FH-48 ML = (FL/4)-20,5
12649 Çita Bead			2Pcs / Adet	BL³ = FL-2(ML+37,5)
1745 Çita Bead			4Pcs / Adet	BL¹ = (FL/4)-60
			4Pcs / Adet	BH¹ = FH - 92
5842-5842 Adaptör Adapter			1Pcs / Adet	AH = FH-98

CAM / GLASS

Kod Code	Çizim Drawing	Miktar Quantity	Ölçüler Dimensions
CAM GLASS		2 Pcs / Adet	GL¹ = (FL/4)-70
			GH¹ = FH-58
CAM GLASS		2 Pcs / Adet	GL² = (FL/4)-70
			GH² = FH-234

CAM ÖLÇÜLERİ EŞİT KABUL EDİLEREK
FORMULİZE EDİLMİŞTİR.

GLASS DIMENSIONS ARE
FORMULATED, ACCEPT EQUAL.

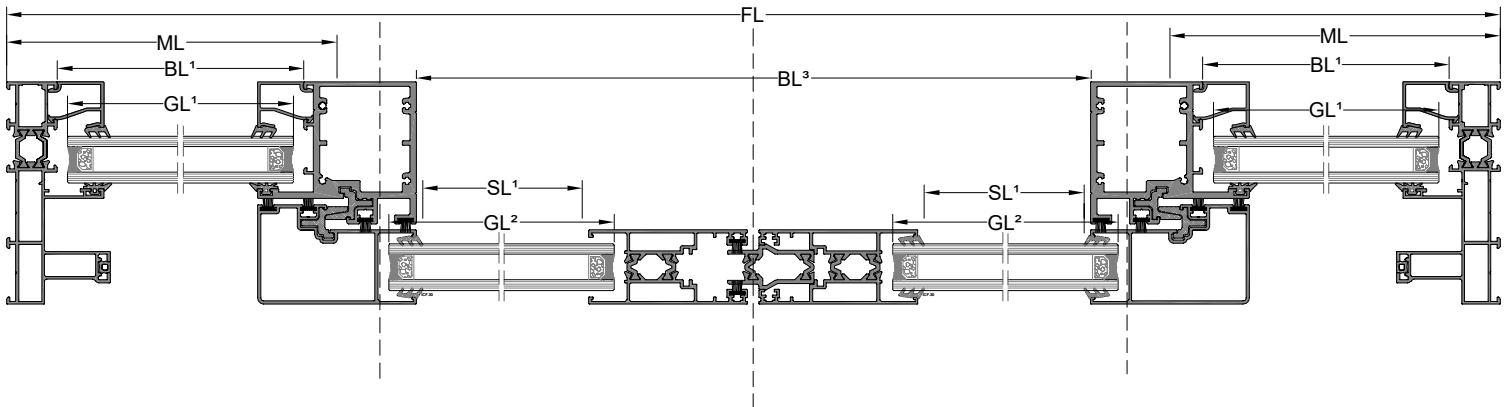

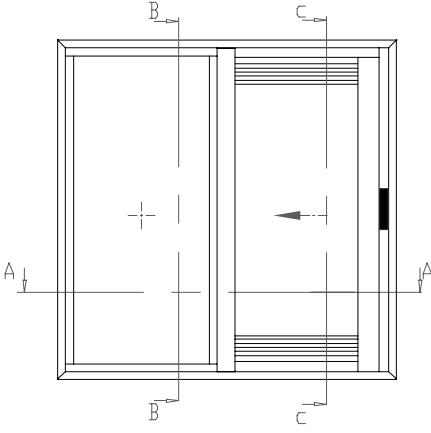

B-B KESİTİ

C-C KESİTİ

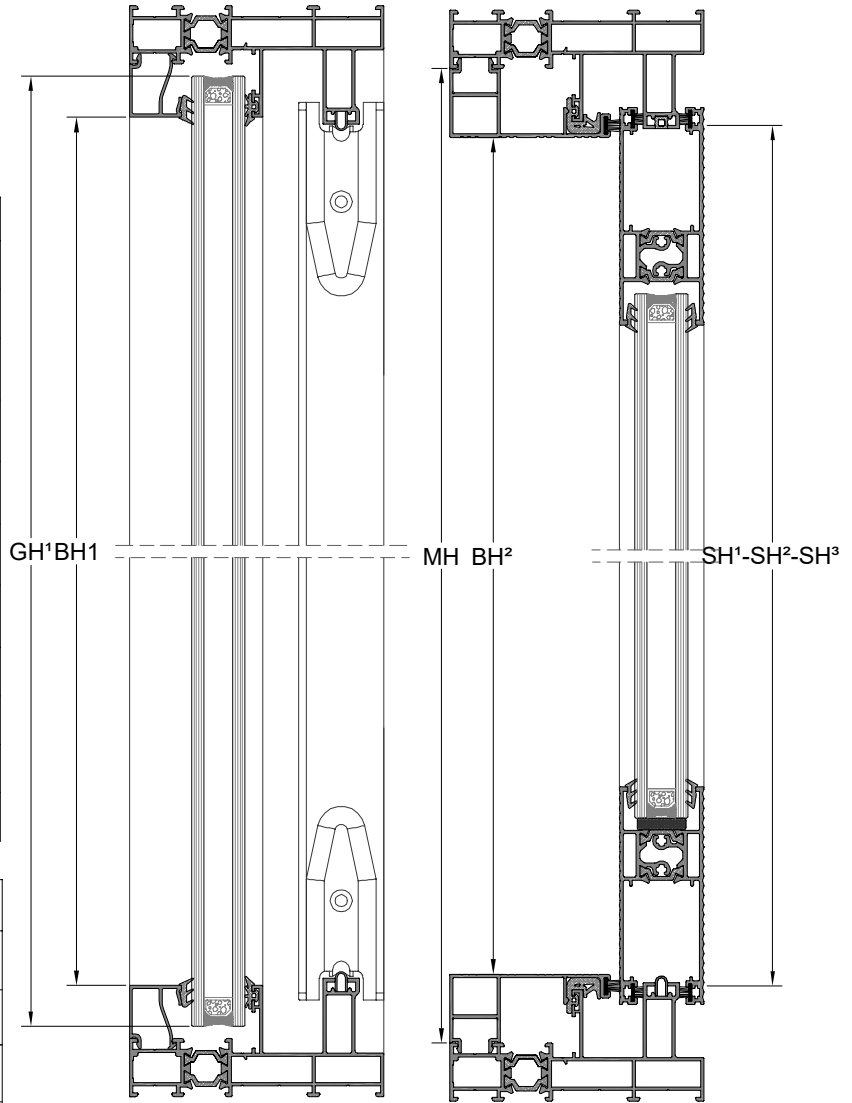

PROFİLLER / PROFILES

Kod Code	Çizim Drawing	Kesim Cut	Miktar Quantity	Ölçüler Dimensions
12651-12652 Kasa Frame			2 Pcs / Adet	FL
			2 Pcs / Adet	FH
5841-5841 Kanat Sash			1Pcs / Adet	SH¹= FH-86
5830 Kanat Sash			1Pcs / Adet	SH²= FH-86
5831 Kanat Sash			1Pcs / Adet	SH²= FH-86
5859-5860 Kanat Sash			2Pcs / Adet	SL= (FL/2)-102,5
12655 Kenet Sash			1Pcs / Adet	MH = FH-48 ML =(FL/2)-37
1745 Çita Bead			2Pcs / Adet	BL¹ = (FL/2)-79
			1Pcs / Adet	BH¹ = FH - 92
12649 Çita Bead			2Pcs / Adet	BL² = (FL/2)-6
			1Pcs / Adet	BH² = FH-105

CAM / GLASS

Kod Code	Çizim Drawing	Miktar Quantity	Ölçüler Dimensions
CAM GLASS		1 Pcs / Adet	GL¹ = (FL/2)-71
			GH¹ = FH-58
CAM GLASS		1 Pcs / Adet	GL² = (FL/2)-71
			GH² = FH-234

CAM ÖLÇÜLERİ EŞİT KABUL EDİLEREK FORMULİZE EDİLMİŞTİR.

GLASS DIMENSIONS ARE FORMULATED, ACCEPT EQUAL.

A-A KESİTİ

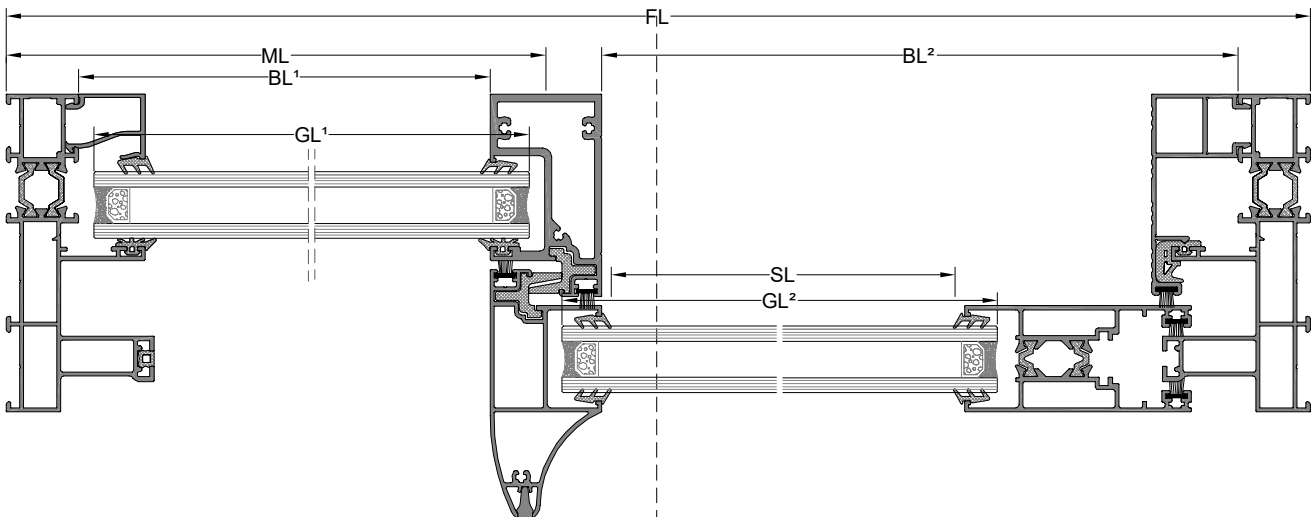

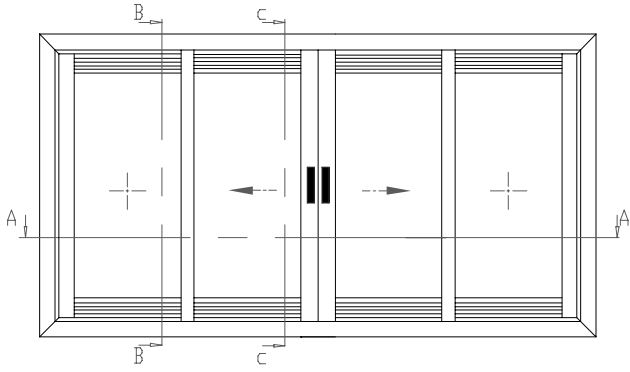

B-B KESİTİ

C-C KESİTİ

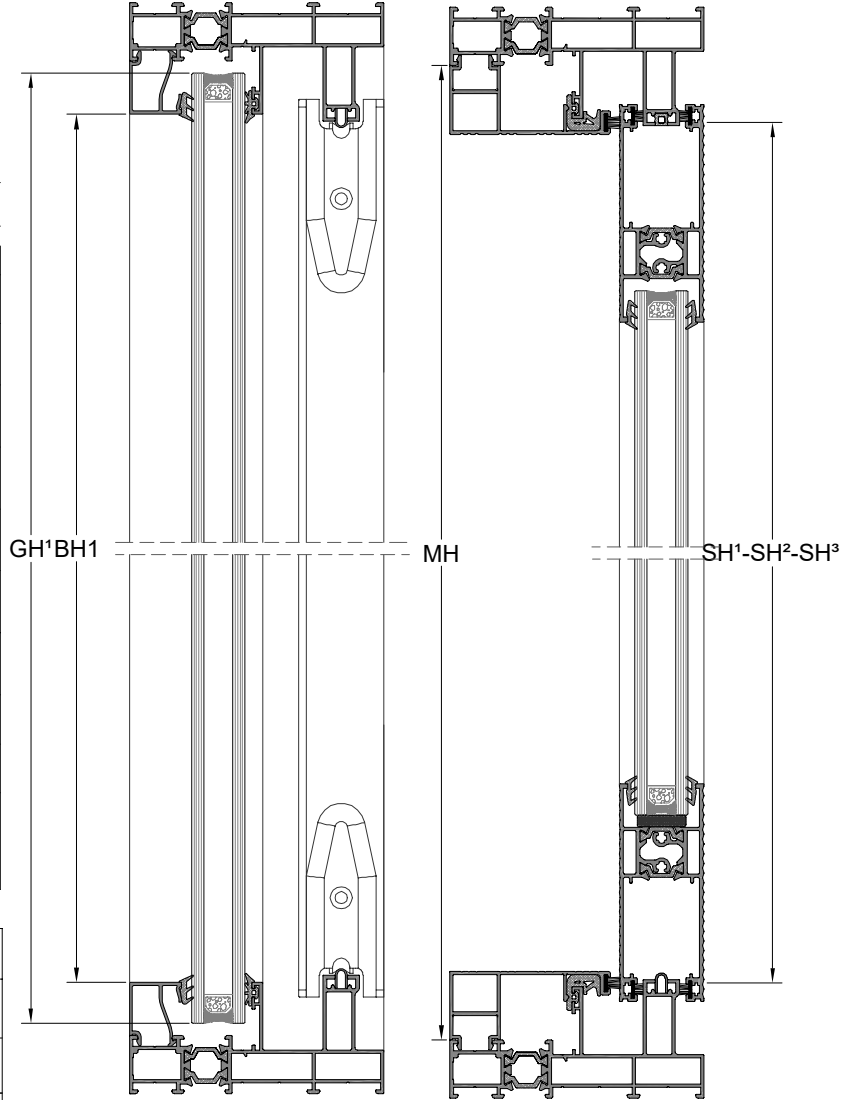

PROFİLLER / PROFILES

Kod Code	Çizim Drawing	Kesim Cut	Miktar Quantity	Ölçüler Dimensions
12651-12652 Kasa Frame			2 Pcs / Adet	FL
			2 Pcs / Adet	FH
5841-5841 Kanat Sash			2Pcs / Adet	SH¹= FH-86
5830 Kanat Sash			2Pcs / Adet	SH²= FH-86
5831 Kanat Sash			2Pcs / Adet	SH²= FH-86
5859-5860 Kanat Sash			4Pcs / Adet	SL¹= (FL/4)-84
12655 Kenet Sash			2Pcs / Adet	MH = FH-48 ML = (FL/4)-18,5
12649 Çita Bead			2Pcs / Adet	BL² = FL-2(ML+18,5)
1745 Çita Bead			4Pcs / Adet	BL¹ = (FL/4)-61
			2Pcs / Adet	BH¹ = FH - 92
5842-5842 Adaptör Adapter			1Pcs / Adet	AH = FH-98

CAM / GLASS

Kod Code	Çizim Drawing	Miktar Quantity	Ölçüler Dimensions
CAM GLASS		2 Pcs / Adet	GL¹ = (FL/4)-53
			GH¹ = FH-58
CAM GLASS		2 Pcs / Adet	GL² = (FL/4)-53
			GH² = FH-234

CAM ÖLÇÜLERİ EŞİT KABUL EDİLEREK
FORMULİZE EDİLMİŞTİR.

GLASS DIMENSIONS ARE
FORMULATED, ACCEPT EQUAL.

A-A KESİTİ

